

QuNexus Reference Manual

QuNexus Version 1.1.1
July, 2013

Keith McMillen, Conner Lacy, Nick Wang, Evan Adams, Jimmy Allison, Jasmin Blasco, Diane Douglas, Tom Ferguson, Steven Fruhwirth, Paul Gaeta, Ingmar Gorman, Christian Heilman, Matthew Hettich, Sarah Howe, William Leach, Daniel McAnulty, Jon Short, Carson Whitley, and Steve Wright



Copyright 2007-2013 Keith McMillen Instruments a wholly owned subsidiary of Kesumo LLC. All rights reserved. Made in USA.

No part of this manual may be reproduced or transmitted in any form or for any purpose without the express written permission of the copyright holders.

The content of this manual is furnished for informational use only, is subject to change without notice, and should not be construed as a commitment by Keith McMillen Instruments. Every effort has been made to ensure that the information in this manual is accurate. No warranties, express or implied, are made with regard to the quality, suitability or accuracy of this document. Keith McMillen Instruments reserves the right to change the contents of this document and/or the associated products at any time without the provision of prior notice to specific persons or organizations. Keith McMillen Instruments shall not be held liable for damages of any kind arising from the use, or the inability to use this product or its documentation, even if the possibility of such damage is known.

Product and brand names contained in this document are used for identification purposes only. Keith McMillen Instruments, the Keith McMillen Instruments Logo, the QuNexus and QuNexus logo are trademarks of Kesumo LLC. Apple, Finder, GarageBand, Logic, Mac, MacBook, Macintosh, Mac OS and QuickTime are trademarks of Apple Inc, registered in the U.S. and other countries. Windows is a registered trademark of Microsoft Corporation in the United States and other countries. Intel is a registered trademark of Intel Corporation or its subsidiaries in the United States and other countries. SONiVOX is the brand name trademark of Sonic Network, Inc. VST and ASIO are trademarks and software of Steinberg Media Technologies GmbH. Reason, ReWire, Recycle and REX2 are trademarks of Propellerhead Software AB. All other product and company names are trademarks or registered trademarks of their respective holders. All other names and designations of companies, products, trademarks, or brands used in this document are the registered property of their respective holders.

Table of Contents

[Chapter 1 Welcome](#)

- [1.1 Questions or Feedback? Contact us!](#)
- [1.2 What's in the QuNexus Package?](#)

[Chapter 2 QuNexus Hardware / Getting Started](#)

- [2.1 Connecting QuNexus](#)
- [2.2 Input/Output Routing](#)
 - [2.2.1 USB](#)
 - [2.2.2 MIDI](#)
 - [2.2.2.1 The KMI MIDI Expander](#)
 - [2.2.3 CV](#)
 - [2.2.3.1 Cable Connections](#)
 - [2.2.3.2 CV Cable Kit](#)
 - [2.2.3.3 CV Data](#)
 - [2.2.3.4 Converting CV Input from +/- 10V to 0V/5V](#)
 - [2.2.3.5 Dual Expression and Sustainer Inputs](#)
 - [2.2.4 Converting Data Types](#)
- [2.3 Left Side Buttons](#)
 - [2.3.1 The Oct Buttons](#)
 - [2.3.2 The Bend Pad](#)
 - [2.3.3 The Shift / Preset Button](#)
 - [2.3.3.1 Selecting Presets](#)
 - [2.3.4 Togl A, Velo B, Pres C, & Tilt D](#)
- [2.4 Data Sources and Sensor Output](#)
 - [2.4.1 Factory Presets](#)
 - [2.4.2 CoMA Mode](#)
 - [2.4.2.1 CoMA Mode Mapping Guide](#)
- [2.5 Live Edit Mode](#)
- [2.6 Controlling LEDs](#)

[Chapter 3 QuNexus Editor](#)

- [3.1 System Requirements](#)
- [3.2 Installing the Software](#)
- [3.3 Updating the Firmware](#)
- [3.4 Main Window Overview](#)
- [3.5 Saving Presets](#)
 - [3.5.1 Importing and Exporting Presets](#)
- [3.6 Menu Bar](#)
- [3.7 Sensitivity](#)
 - [3.7.1 Per Key Sensitivities](#)
- [3.8 Keyboard Layer](#)
 - [3.8.1 Types](#)
 - [3.8.2 Sources](#)
 - [3.8.3 Gain, Offset, Curve, Min, and Max](#)
 - [3.8.3.1 View/Edit Tables](#)
 - [3.8.4 Out](#)

- [3.8.5 MIDI Channel](#)
- [3.8.6 Channel Rotation](#)
- [3.8.7 Toggle](#)
- [3.8.8 Transpose](#)
- [3.8.9 LEDs Local/Remote](#)
- [3.8.10 Program Change](#)
- [3.8.11 Bend Range](#)
- [3.8.12 Key Priority](#)
- [3.9 Controller Layer](#)
 - [3.9.1 Sensor Settings](#)
 - [3.9.1.1 Participate](#)
 - [3.9.1.2 Controller Layer Sources](#)
 - [3.9.1.3 Controller Layer Toggle](#)
- [3.10 CV Layer](#)
 - [3.10.1 CV Output \(MIDI to CV\)](#)
 - [3.10.2 CV Input \(CV to MIDI\)](#)
 - [3.10.3 CV Trims](#)

- [Chapter 4 Troubleshooting](#)
- [4.1 Connectivity Trouble](#)
 - [4.1.1 Touchy USB Connection](#)
- [4.2 CV Trouble](#)
 - [4.2.1 Steps to Convert MIDI to CV](#)
 - [4.2.2 Audible High Pitched Noise in Computer Audio when using CV](#)
 - [4.2.3 QuNexus LEDs Light Up Erratically When Receiving CV](#)
- [4.3 Firmware Trouble](#)
 - [4.3.1 QuNexus Doesn't Do Anything After a Firmware Update](#)
 - [4.3.2 Firmware Update Freezes or Doesn't Work](#)
 - [4.3.3 General Firmware Information and Suggestions](#)
 - [4.3.3.1 Unplug Other USB Devices](#)
 - [4.3.3.2 Try a New Micro-USB Cable](#)
 - [4.3.3.3 "Hotplugging" on Windows](#)
 - [4.3.3.4 Don't Send MIDI to QuNexus During an Update](#)
 - [4.3.3.5 If Things are Working Fine, DON'T Update Right Before your Show](#)
 - [4.3.3.6 Manually Updating Firmware](#)
- [Safety Precautions](#)

Chapter 1 Welcome

QuNexus is a vividly illuminated keyboard controller that is fun for beginners and a must for professionals. 25 touch-sensitive keys detect finger pressure, velocity, and tilt, giving you an unprecedented degree of musical control. Blue and white LEDs with 16 levels of brightness give you valuable feedback. Use the toggle feature to build chords and create your own step sequencer or arpeggiator with LED feedback.

QuNexus is your hub for new and vintage technology. Plug into your computer, iPad (Apple Camera Connector required), or Android tablet via USB. Control hardware via 5-PIN MIDI (MIDI Expander required) or control your modular synthesizers with the included CV inputs and outputs.

In this manual you will find detailed information to help answer all of your questions about QuNexus hardware and software.

1.1 Questions or Feedback? Contact us!

If at any time you have any questions, please contact us:

Web: www.keithmcmillen.com

Forum: forum.keithmcmillen.com

Support: www.keithmcmillen.com/support

1.2 What's in the QuNexus Package?

When you open up the box you should find:

- (1) QuNexus
- (1) USB A-to-Micro cable (1 meter)



Chapter 2 QuNexus Hardware / Getting Started

QuNexus is a class compliant USB device that does not require a driver or software to function. Out of the box QuNexus has everything needed to get started. We also provide a QuNexus Editor application (for Mac and Windows), which allows further customization (discussed in Chapter 3). This chapter is a guide to getting started using QuNexus out of the box and will provide detailed information about how to use the hardware features of QuNexus.

Dimensions: 12.8" x 3.3" x 0.43" (inches).
325mm x 84mm x 11mm

Weight: 0.76 lb / 345 g

There are no user serviceable parts inside QuNexus. Attempts to open the enclosure will void the warranty.

2.1 Connecting QuNexus

These images are not to scale.

Connect QuNexus to a computer:

This image shows QuNexus set up to send MIDI data to a computer. Use a USB A-to-Micro cable to connect the QuNexus micro port to a USB port on a computer. QuNexus will receive power from the computer.

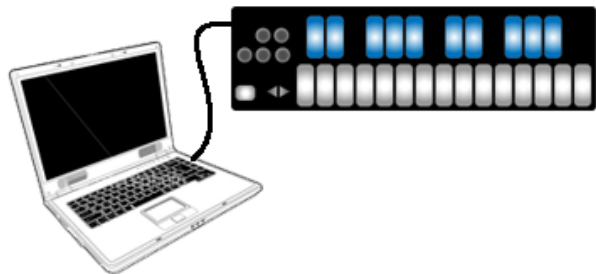

Connect QuNexus to an iPad:

The image shows QuNexus connected to an iPad via USB. You will need the iPad Camera Connection Kit (sold by Apple: <http://store.apple.com/us/product/MC531ZM/A>). Attach the camera connector to the iPad and then use a USB A-to-Micro cable to connect the QuNexus micro port to the camera connector.

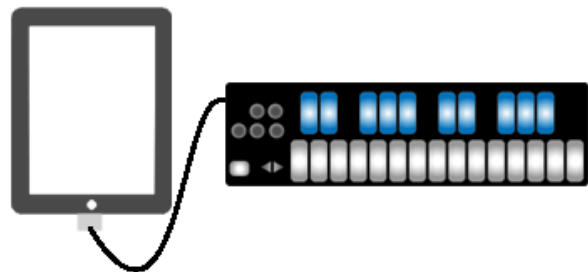

See the [USB](#) chapter for more information.

Connect QuNexus to MIDI hardware:

The image shows QuNexus connected to a hardware MIDI device via our MIDI Expander (sold separately):

1. Use a USB A-to-Mini cable to connect the QuNexus Mini port (on the right side of the QuNexus) to the USB “Expand” port on the MIDI Expander.
2. Connect the power supply to the MIDI Expander USB “Power” port.
3. Connect the MIDI Out on the Expander to the MIDI In on a synth or other MIDI device.

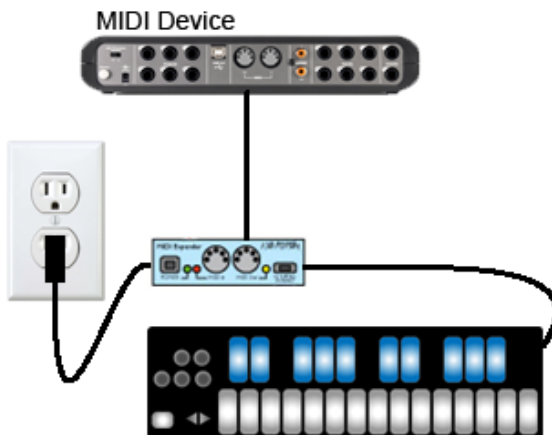

Connect QuNexus to MIDI hardware (Powered by Computer):

The image shows QuNexus connected to a Computer and a hardware MIDI device via our MIDI Expander (sold separately):

1. Use a USB A-to-Mini cable to connect the QuNexus Mini port (on the right side of the QuNexus) to the USB “Expand” port on the MIDI Expander.
2. Use a USB A-to-Micro cable to connect the QuNexus micro port to a USB port on a computer. QuNexus will receive power from the computer.
3. Connect the MIDI Out on the Expander to the MIDI In on a synth or other MIDI device.

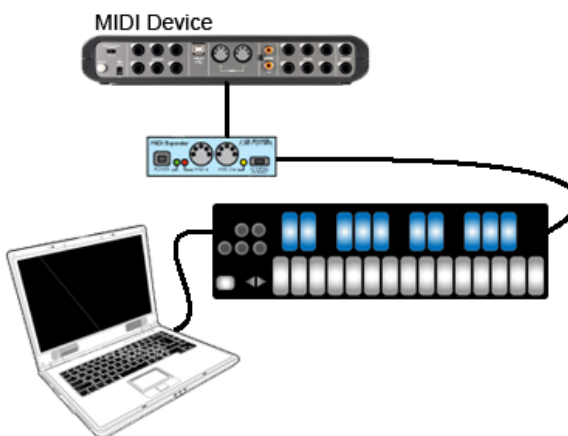

See the [MIDI](#) chapter for more information.

Connect QuNexus to Synthesizers or other CV devices:

The images to the right below show QuNexus connected to a CV device. There are 3 different ways to set this up:

Powered by a Computer (or iPad):

1. Use a USB A-to Micro cable to connect the QuNexus Micro port to a USB port on a computer or iPad. This connects the QuNexus to power.
2. Use a cable that is compatible with your CV device’s CV ports. Using adapters if needed, make sure one end can plug into one of the stereo 1/8in. CV out ports on the QuNexus.
3. Plug your cable into the “Gate-CV1 Out” port on the left side of the QuNexus. Plug the other end into the desired destination on your CV device.

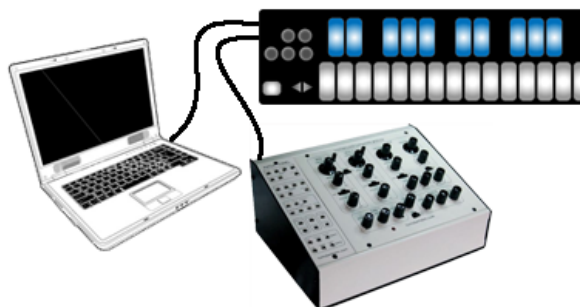

Powered by KMI MIDI Expander:

1. Use a USB A-to-Mini cable to connect the QuNexus Mini port (on the right side of the QuNexus) to the USB "Expand" port on the MIDI Expander.
2. Connect the power supply to the MIDI Expander USB "Power" port.
3. See steps 2 and 3 from the "Powered by a Computer" steps.

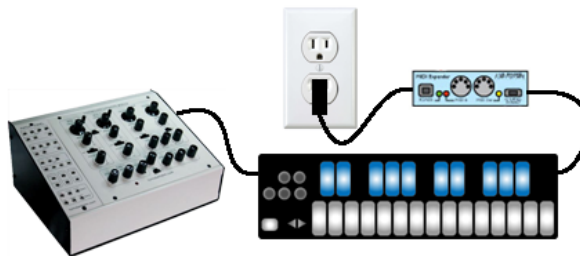

Powered by USB Power Supply:

1. Use a USB A-to-Mini cable to connect the QuNexus Mini port (on the right side of the QuNexus) to a USB Power Supply.
2. Connect the Power Supply to a power outlet.
3. See steps 2 and 3 from the "Powered by a Computer" steps.

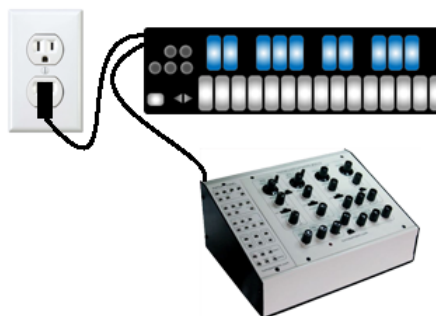

See the [CV](#) chapter for more information.

2.2 Input/Output Routing

QuNexus can output USB, Control Voltage, and MIDI (using a KMI MIDI Expander - sold separately). Each of these data types can be routed to one or both of the other data types.

The image to the right shows the QuNexus as the hub of three types of devices. The black lines represent the physical connections that are made between each instrument. The blue circle represents the possible communication between each instrument when using the QuNexus as the central device in the setup.

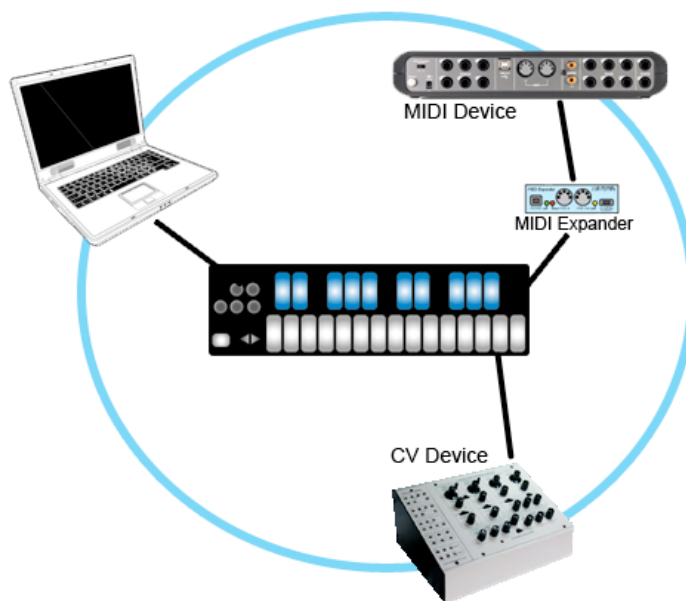

The subchapters below will focus one at a time on each data type's communication with QuNexus and then provide detail about converting one data type to another.

2.2.1 USB

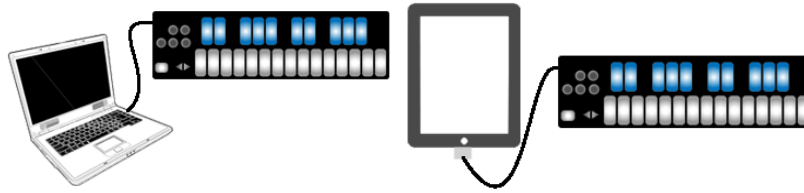

QuNexus is [connected](#) and powered using the Micro USB port on the left side of the QuNexus. It is a class compliant USB device and does not require a driver. This allows for maximum compatibility with an extremely wide range of other devices.

QuNexus has 3 virtual MIDI ports that communicate with the computer. Port 1 is the main port on which the QuNexus sends and receives MIDI data to and from the computer or iPad. Port 2 and 3 can be used for this purpose as well but are also used for communication with other devices. Port 2 is used for the KMI MIDI Expander (sold separately) and Port 3 is used for CV.

A computer or iPad can control the QuNexus LEDs by sending MIDI data into the QuNexus on Port 1 (see the [Controlling LEDs](#) chapter for more information).

2.2.2 MIDI

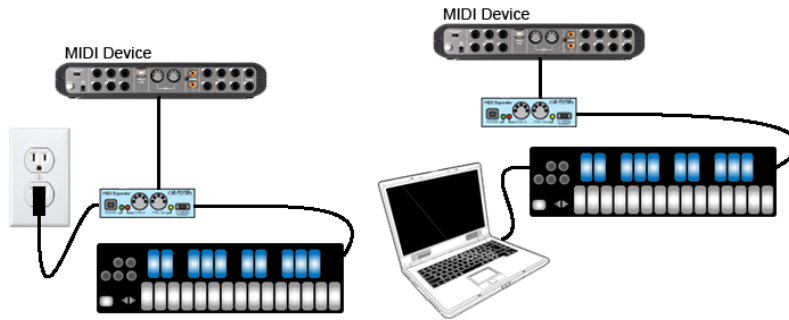

The KMI MIDI Expander is required to send and receive MIDI Data via 5-pin MIDI devices. The MIDI Expander can be used with or without a computer or iPad connected. Power is supplied to QuNexus from the MIDI Expander's power port when the MIDI Expander is plugged into a power outlet. If connected to a computer (or iPad) and a MIDI Expander, power is supplied to the QuNexus from the Micro USB port instead of the Expander.

2.2.2.1 The KMI MIDI Expander



The KMI MIDI Expander is an optional accessory, which enables use of QuNexus with hardware MIDI devices. Plug the receiving MIDI device into the MIDI Out port and QuNexus will send MIDI data through a regular 5-pin MIDI cable.

Dimensions: 4" x 1.25" x 1.25" (inches).

Weight: 2.5 oz.

To use QuNexus with the KMI MIDI Expander follow these steps:

1. Connect a QuNexus to the KMI MIDI Expander (see [Connecting QuNexus](#) for instructions).
2. Plug MIDI devices into the MIDI Expander using 5-pin MIDI cables. The QuNexus will now send and receive MIDI messages through the MIDI Expander.

2.2.3 CV



QuNexus can communicate with synthesizers or other CV devices using Control Voltages. [Connect](#) QuNexus to CV devices using a cable that is compatible with your CV device's CV ports. Using adapters if needed, make sure one end can plug into one of the stereo 1/8in CV out ports on the left side of QuNexus. QuNexus' CV input port (on the right side) requires one end to be a 3.5 mm TRRS (like the ones used for Apple iPhone headsets).

Warning: QuNexus' CV In is uni-polar. If you send it a bi-polar signal, half of the signal will be clipped and can cause malfunctions in extreme cases. Sending a signal above 5 Volts is also unsupported. See the [Converting CV Input from +/- 10V to 0V/5V](#) chapter for information on how to make a converter.

The following section provides more detail about the cable connectors needed for QuNexus CV.

2.2.3.1 Cable Connections

There are 2 CV output ports on the left side of the QuNexus and 1 CV input port on the right side.

Outputs - Since the two output ports use stereo 1/8in connectors (TRS - shown below), they provide 4 outputs: a gate output and three 16-bit CV outputs. Output voltages range from 0 to 5V.

Inputs - The input port should be used with a TRRS connector (shown below) to access both CV inputs and the 5V Power for an expression pedal. QuNexus' CV In is uni-polar. If you send it a bi-polar signal, half of the signal will be clipped and can cause malfunctions in extreme cases. Sending a signal above 5 Volts is also unsupported.

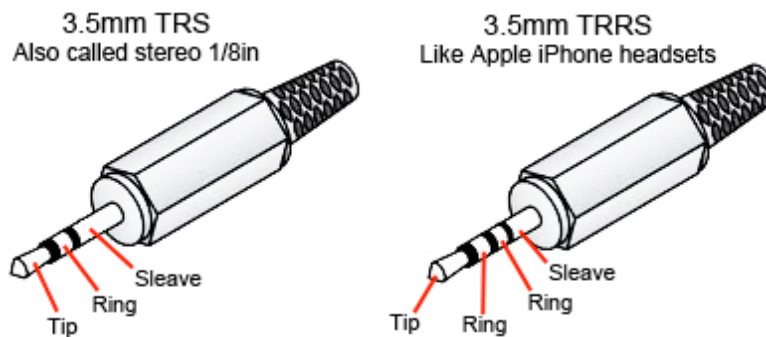

These are the 2 types of plugs that are required to plug QuNexus into a CV device. The TRS type is for the CV output ports and the TRRS type is for the CV input port.

The image below gives a detailed view of the 2 QuNexus CV output ports and the CV input port:



- Output CV Port 1
 - Tip - CV 1
 - Ring - Gate
- Output CV Port 2
 - Tip - CV 3
 - Ring - CV 2
- Input CV Port 1
 - Tip - CV 1
 - 1st Ring - 5 volts out for expression pedal power
 - 2nd Ring - CV 2

When using a y-cable or adapter to split the QuNexus CV outputs to get mono outputs, the tip is black (or white) and the ring is red. This can vary from cable to cable.



When using a cable or adapter to split the QuNexus CV input port to get 2 mono inputs and 5V power: tip is white (or black), 1st ring is red, and the 2nd ring is yellow. This can vary from cable to cable.



Tip: After splitting the outputs to mono, make sure to use mono adapters and cables to get the signal the rest of the way to your CV device(s).

Note about Expression Pedals: Not all Expression Pedals work well. Some are noisier than others. Yamaha Pedals are known to misbehave because they don't function as a voltage divider. We recommend the Roland EV-5.

2.2.3.2 CV Cable Kit

The QuNexus CV Cable Kit is an optional add on, which makes it easy to gather the cables and adapters needed to convert MIDI to CV and vice versa using QuNexus.

One of each of the following cables/adapters is included in the CV Cable Kit:

CV INPUT:

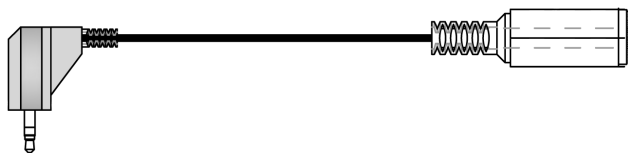

right angle 3.5mm (1/8in) stereo plug to 1/4in stereo jack
This is helpful when connecting an Expression Pedal to the CV 1-2 in port



3.5mm (1/8in) stereo plug to 1/4in mono jack
This is helpful when connecting a Sustain Pedal to the CV 1-2 in port

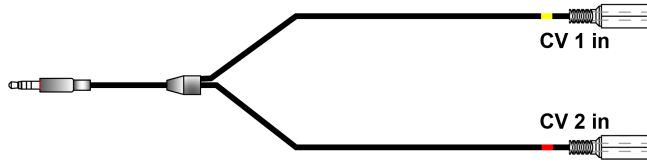

3.5mm (1/8in) TRRS plug to dual 3.5mm (1/8in) stereo jacks
 This is helpful for splitting the CV input port into CV1 (expression pedal) and CV2
Tip: make sure to use stereo 1/8in cables to plug into the jacks

CV OUTPUT:

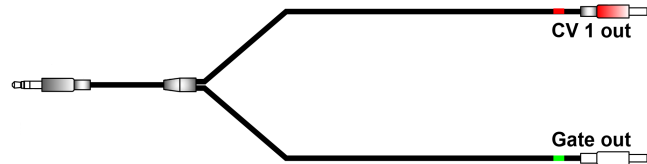

3.5mm (1/8in) stereo plug to dual 3.5mm (1/8in) mono plugs
 This is helpful for splitting the first CV output into Gate and CV1

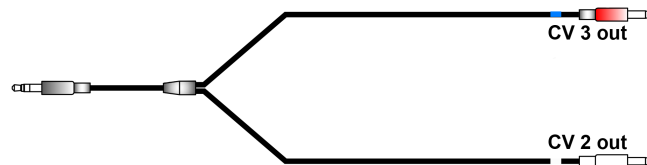

3.5mm (1/8in) stereo plug to dual 3.5mm (1/8in) mono plugs
 This is helpful for splitting the second CV output into CV2 and CV3

2.2.3.3 CV Data

Output: By default, QuNexus sends different data out the 4 CV outputs:

- Gate - Note ons and offs. Note ons are expressed as 5 volts.
- CV1 - Pitch
- CV2 - Mod (CC#1)
- CV3 - Pitch Bend

This data can come from the Keyboard, USB Port 3, or the MIDI Expander. By default, MIDI must be received from Channel 2 if sending from USB Port 3 or the MIDI Expander.

Input: By default, QuNexus receives data from the 2 CV inputs and converts them to MIDI messages:

- CV1 - CC#112
- CV2 - CC#113

By default, this data is sent on Channel 2 to USB Port 3 and the MIDI Expander.

2.2.3.4 Converting CV Input from +/- 10V to 0V/5V

QuNexus' CV In is uni-polar. If you send it a bi-polar signal, half of the signal will be clipped and can cause malfunctions in extreme cases. Sending a signal above 5 Volts is also unsupported. You can convert a bi-polar 10V signal to a uni-polar 5V signal. Though we do not provide a converter, you can make one using the schematic shown below:

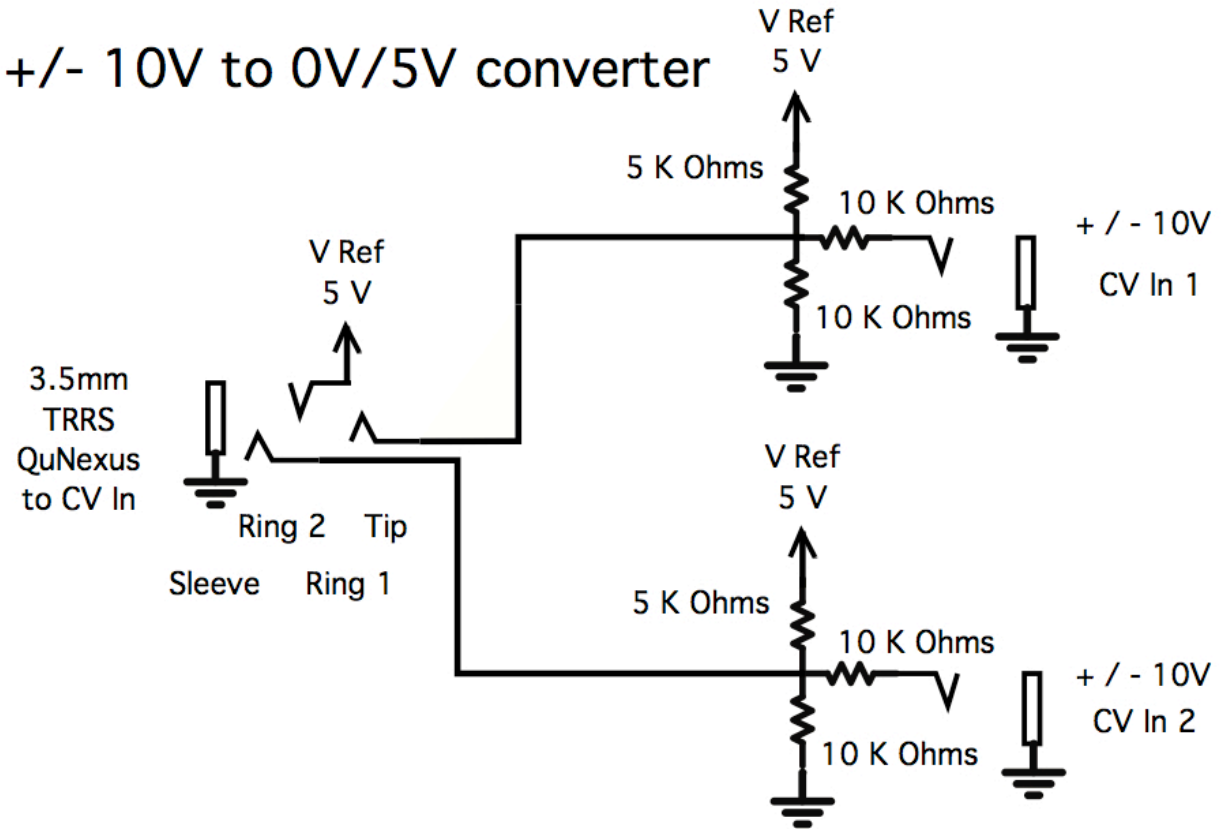

2.2.3.5 Dual Expression and Sustainer Inputs

It is possible to create a TRRS cable wired so that you can use two Expression or Sustainer pedals with QuNexus. Though we do not provide these, you can make them using the schematics shown below:

Dual_0V-5V Expression_Inputs

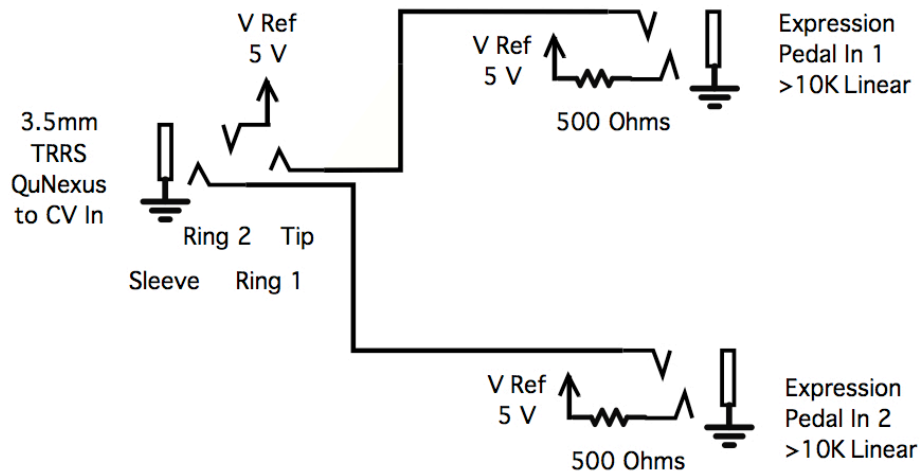

Dual_Sustain_Switch_Inputs

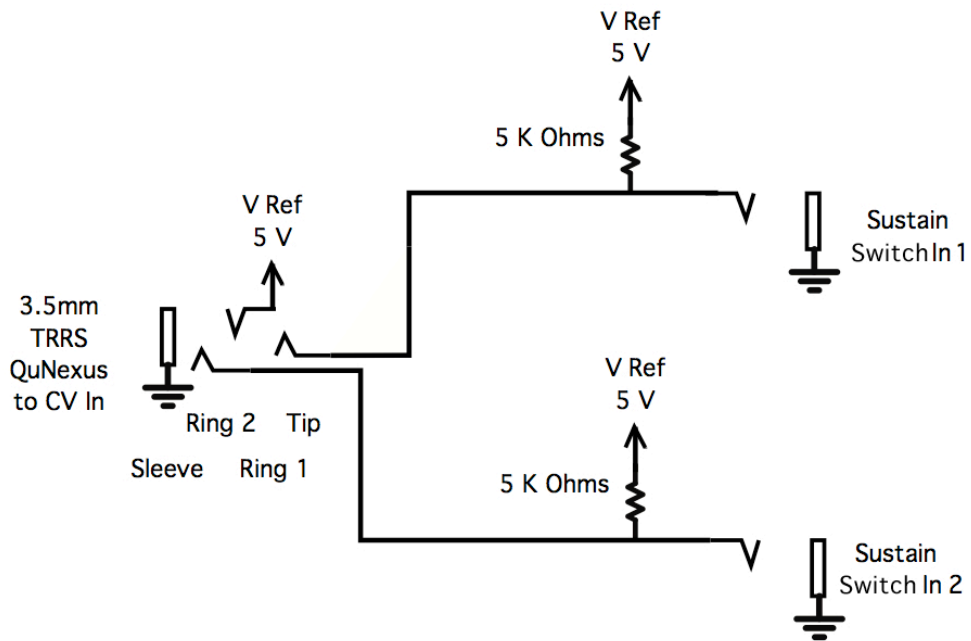

2.2.4 Converting Data Types

It is possible to use QuNexus to convert data from MIDI to CV and vice versa. This can be accomplished in multiple ways:

With a Computer:

The image on the right shows the QuNexus connected to a computer, a CV device, and a MIDI device via the KMI MIDI Expander. By default, the QuNexus will automatically send data to all three.

To get the computer to communicate with the MIDI Device use QuNexus' virtual MIDI Port 2.

For communication between the computer and the CV device use QuNexus' virtual MIDI Port 3.

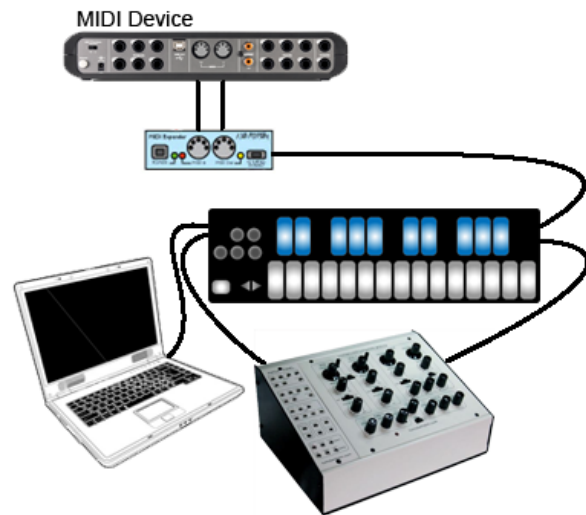

Without a Computer:

Tip: Anything that can be done without a Computer can be done with a computer as well.

For communication from MIDI to CV (whether originating from the MIDI Device or USB), the CV outputs by default are set up to convert data from specific MIDI messages coming from the Keyboard, USB Port 3, and the MIDI Expander. Below is a list of what will output through each of the 4 CV outputs. All 4 Factory Presets are set up to convert MIDI to CV the same way.

Presets A, B, and C listen to Channel 2. Preset D listens to Channel 9.

Gate - Note Ons and Offs.

CV1 - Pitch data from Notes.

CV2 - Anything from CC#1. Nothing will output if the preset does not utilize CC#1 on the corresponding Channel.

CV3 - Pitch Bend data. Nothing will output if the preset does not utilize Pitch Bend on the corresponding Channel.

Changing the MIDI messages that are translated to CV can be accomplished by using the QuNexus Editor to adjust the settings in [CV Layer](#).

For information about how to separate the CV outputs read the [CV Chapter](#) above.

2.3 Left Side Buttons

The buttons on the left side of the QuNexus perform useful functions that alter the behavior of the keyboard. This chapter will explore the use of each button: Togl A, Velo B, Shift/Preset, Pres C, Tilt D, Bend, and the Oct Buttons.



2.3.1 The Oct Buttons

There are 2 triangular Oct buttons that increment or decrement the keyboard octave (Keyboard Layer only). When QuNexus is first plugged in the - and + Oct buttons are both lit up and the keyboard starts at C2 (note 48) and goes up to C4 (note 72). QuNexus treats C3 as note 60. Different MIDI devices and software use different note number to note name conversions. Below is a chart that will help convert note numbers to note names and vice-versa:

C3 = 60

Octave	Note Numbers											
	C	C#	D	D#	E	F	F#	G	G#	A	A#	B
-2	0	1	2	3	4	5	6	7	8	9	10	11
-1	12	13	14	15	16	17	18	19	20	21	22	23
0	24	25	26	27	28	29	30	31	32	33	34	35
1	36	37	38	39	40	41	42	43	44	45	46	47
2	48	49	50	51	52	53	54	55	56	57	58	59
3	60	61	62	63	64	65	66	67	68	69	70	71
4	72	73	74	75	76	77	78	79	80	81	82	83
5	84	85	86	87	88	89	90	91	92	93	94	95
6	96	97	98	99	100	101	102	103	104	105	106	107
7	108	109	110	111	112	113	114	115	116	117	118	119
8	120	121	122	123	124	125	126	127				

The Octave buttons will increment or decrement the QuNexus keyboard by one octave / 12 steps / 1 line (using the chart above). They allow you to shift up 3 octaves or shift down 2 octaves for a total range of 7 octaves (C0 - C7).

The LEDs of the Octave buttons indicate which octave you are in. If the green Oct + button is pressed, the LED will flash on that button, indicating that the octave for the keyboard is raised. The same thing applies for pressing the - Oct button. The LED will flash faster if you raise or lower the keys. When both LEDs are solid again you know you are back to the original octave starting at C2.

2.3.2 The Bend Pad

The Bend Pad is located in the bottom left corner of the QuNexus. It acts similarly to a pitch wheel. When playing the keyboard, if you are holding down a note, pressing the Bend pad will bend the pitch of the note. Shift pressure on the Bend Pad from side to side to bend up and down.

When using a Preset that uses Channel Rotation the Bend Pad sends out on all active Channels. If no keys are held down it will send out on the main starting Channel. See the [Channel Rotation Chapter](#) for more information.

The bend range is in part determined by the software or hardware device used for output but is also set according to the Presets. It is editable in the QuNexus Editor and in Live Edit Mode. See the [Factory Presets](#) chapter for information about what the Bend Range is for each Preset. See the [Bend Range](#) Chapter and the [Live Edit Mode](#) Chapter for more information about adjusting the Bend Range.

2.3.3 The Shift / Preset Button

The Shift / Preset Button (shown to the right) is used for 2 different purposes: to get into Live Edit Mode and to get into Preset Select Mode. Hold down the Shift Button for approximately two and a half seconds to enter Live Edit Mode. For more information about [Live Edit Mode](#) see chapter 2.5. Tap the Preset Button to enter Preset Select Mode.



2.3.3.1 Selecting Presets

There are four Preset slots on QuNexus. To select different presets tap the Shift / Preset button on the left side of the QuNexus. The LEDs on the keyboard will swipe to indicate that you are in Preset Select Mode. Then one of the four lettered buttons will light up to indicate which Preset is currently selected (A, B, C, or D). Next tap one of the four buttons to choose a different Preset. Upon making a selection the LEDs on the keyboard will swipe again to indicate that you are leaving Preset Select Mode and entering the chosen preset.

Steps to select a Preset:

1. Tap the Shift / Preset button.
2. Choose a Preset (A, B, C, or D).

For information about the four Factory Presets see the [Factory Preset chapter](#).

The Factory Presets can be customized and new presets can be created using the [QuNexus Editor](#).

2.3.4 Togl A, Velo B, Pres C, & Tilt D

These buttons turn different functions on and off. To switch them on and off hold down on the button for approximately 1 seconds. The functions they control are listed below:

Togl A - This button turns Toggle Mode on and off for notes in Keyboard Layer*. Presets will always start with the Toggle button off (as shown in the left image below). Depending on the settings of your preset, Toggle Mode will either use Toggle or Legato. The QuNexus Factory Presets all use Toggle. For information about how to set Toggle Mode to use Legato, see the [Toggle](#) section in the QuNexus Editor Chapter.



Togl A is off by Default



Hold Togl A for 1 sec to turn Toggle On

Legato - Pressing a key sends a note on but releasing doesn't send a note off. When a different key is pressed, the previous key's note is turned off along with the new note on. Tap the Togl A button on the left side of the QuNexus to clear a note without having to hit the next one.

Toggle - Pressing a key sends a note on, a second press sends a note off. Pressing a different key sends a note on without turning off the previous key. Tap the Togl A button on the left side of the QuNexus to clear all notes. The LEDs will display which keys are on.

*The Togl A, Velo B, Pres C, and Tilt D switches only affect the notes and sources in Keyboard Layer. For more information about Keyboard Layer see the [Keyboard Layer](#) chapter.

Velo B - This button turns velocity response on and off for notes in Keyboard Layer*. If the blue LED is lit velocity response is on. If the LED is off then the velocity of each note will be 127.



Velo B is on by Default



Hold Velo B for 1 sec to turn Velocity Off

Pres C - Turn on and off anything assigned to the pressure source in Keyboard Layer* with this button.



Pres C is on by Default



Hold Pres C for 1 sec to turn Pressure Off

Tilt D - Turn on and off anything assigned to the tilt source in Keyboard Layer* with this button.



Tilt D is on by Default



Hold Tilt D for 1 sec to turn Tilt Off

*The Togl A, Velo B, Pres C, and Tilt D switches only affect the notes and sources in Keyboard Layer. For more information about Keyboard Layer see the [Keyboard Layer](#) chapter.

2.4 Data Sources and Sensor Output

QuNexus can output MIDI data that comes from several different sources: Key Velocity, Pressure, Tilt, and Expression Pedal. Listed below are definitions for each of these:

Key Velocity (for notes only): The value between 0 and 127 that represents the overall pressure on the QuNexus keys at the moment a note on (or finger on) is detected. Sensitivity can be adjusted using the QuNexus Editor (see the [QuNexus Editor](#) chapter for more information).

Pressure: Continuous values (between 0 and 127) represent the applied pressure of your finger on the QuNexus keys.

Tilt: Continuous values (between 0 and 127) represent the tilt of your finger on the QuNexus keys. By default this requires an intentional pressure shift/tilt of your finger to engage bend.

Expression Pedal: When an expression pedal is plugged into the CV input of QuNexus, the expression pedal data will be converted to MIDI CC# 112 or 113 on Channel 2 and go from 0 - 127. This behavior can be changed using the QuNexus Editor. See the Chapter on [CV Layer](#) for more information.

Note about Expression Pedals: Not all Expression Pedals work well. Some are noisier than others. Yamaha Pedals are known to misbehave because they don't function as a voltage divider. We recommend the Roland EV-5.

Being aware of the data sources that the QuNexus provides will help in understanding how QuNexus uses this data and how it is converted to MIDI and CV. The next chapter will let you know how the sources are used for each Factory Preset that comes on the QuNexus.

2.4.1 Factory Presets

Preset A (Basic) - The Basic preset functions as a traditional MIDI keyboard and will work with any MIDI-enabled software. Though some of the more exciting functions are turned off, the basic preset outputs notes with a variable velocity and is a great starting point when working with QuNexus!

- MIDI outputs on Channel 1 through USB and MIDI Expander.
- Velocity is on.
- Local LED Control is on.
- Channel Rotation is off.
- Pitch Bend Range is set to 2 semitones.
- Controller Layer is not active on any keys.
- Control Voltage (CV) output and input are enabled with pitch, gate, and bend all being sent out of the CV outputs.

Preset B (Press and Tilt) - The Press and Tilt preset was designed for a wide variety of synths, apps, and plugins with pitch bend and modulation functionality. This preset maps QuNexus' key tilt to pitch bend, and pressure sensitivity to the modulation parameter in most synths. Right out of the box, most iOS music apps -- like Animoog, Sunrizer and Magellan -- will work with this preset, allowing for a more exciting and expressive playing experience!

- MIDI outputs on Channel 1 through USB and MIDI Expander.
- Velocity is on.
- Local LED Control is on.
- Channel Rotation is off.
- Tilt is mapped to Pitch Bend for all keys.
- Pitch Bend Range is set to 2 semitones.
- Pressure is mapped to CC#1 (Mod).
- Controller Layer is not active on any keys.
- Control Voltage (CV) output and input are enabled with pitch, gate, bend, and pressure all being sent out of the CV outputs.

Preset C (Poly Pitch Bend) - The Poly Pitch Bend preset allows for individual pitch and modulation amounts on different keys by outputting each key's message on its own MIDI channel. This functionality, which we call Channel Rotation, allows each key to send its own pitch bend message. Basically, when using the Poly Pitch Bend preset you have 10 pitch bend wheels -- one at the tip of each finger. The Poly Pitch Bend preset will work well with any omni-voiced synth or sampler -- like Native Instruments' Kontakt -- or any performance DAW -- like Ableton Live!

- MIDI Channel Rotation is on (see the [Channel Rotation](#) chapter for more information).
- MIDI outputs through USB and MIDI Expander.
- Velocity is on.
- Local LED Control is on.
- Tilt is set to Pitch Bend for all keys.
- Pitch Bend Range is set to 2 semitones.
- Pressure is mapped to CC#1 (Mod).
- Controller Layer is not active on any keys.
- Control Voltage (CV) output and input are enabled with pitch, gate, bend, and pressure all being sent out of the CV outputs.

Preset D (Drums & Clips) - This preset was designed for playing drum sounds/samples and launching clips in Ableton Live. This preset is most useful when paired with our Ableton Live MIDI Remote script, but will also work well with any synth or drum machine that is mapped to the general MIDI standard for Drums.

- MIDI Notes in Keyboard Layer output on Channel 10 (the Channel typically used for Drums) through USB and MIDI Expander.
- Velocity is on for notes in Keyboard Layer and off for notes in Controller Layer.
- Local LED Control is off. Remote LED messages are received through Channel 9.
- Channel rotation is off.
- Tilt is set to Pitch Bend for all keys in Keyboard Layer.
- Pitch Bend Range is set to 2 semitones.
- Pressure is mapped to CC#1 (Mod) in Keyboard Layer.
- Notes and CC#s in Controller Layer output on Channel 9.
- Controller Layer Notes are active for all Keys.
- Controller Layer Pressures and Tilts are active for all Keys. Pressure returns to 0 and Tilt returns to 63.
- Controller Layer Toggles are not enabled.
- Control Voltage (CV) output and input are enabled with pitch, gate, bend, and pressure all being sent out of the CV outputs.

These four presets can be customized using the QuNexus Editor. See the [QuNexus Editor](#) Chapter for more information.

2.4.2 CoMA Mode

Many DAWs and performance software tools like Ableton Live and Apple's Logic have MIDI Mapping modes that will recognize MIDI data from a controller and map it to whatever you choose. Since the QuNexus can have multiple data sources outputting from one key, it is often necessary to use the Controller Mapping Assistant (CoMA). CoMA mode allows quick mapping of each available data source one at a time, enabling rapid and efficient software/controller pairings.

2.4.2.1 CoMA Mode Mapping Guide

To enter CoMA Mode:

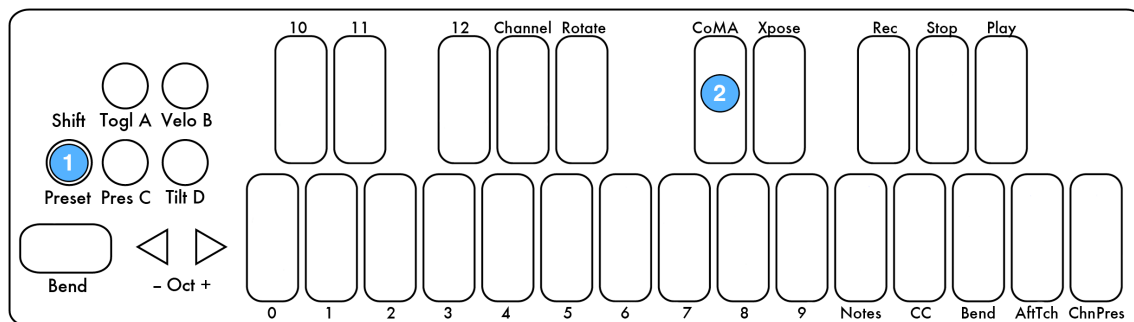

1. Hold down the Shift Button (for about 2.5 seconds) until the Shift Button turns blue and stays on. This puts you in Live Edit Mode.
2. Hit the key labeled "CoMA".

Tap the Shift Button to exit CoMA Mode and go back to playing QuNexus normally.

CoMA will work differently depending on whether Channel Rotation is turned on. To check whether or not Channel Rotation is on after performing step 1 above, check to see if the Rotate key is lit up. If so, Channel Rotation is on.

Channel Rotation is only turned on in the QuNexus Factory Preset C. To make a custom preset with Channel Rotation you will need to turn it on in the QuNexus Editor (see the [Channel Rotation](#) chapter for more information).

There are also a few differences when mapping MIDI from Keyboard Layer vs. Controller Layer. Switch between Keyboard Layer and Controller Layer by holding the Togl button for 1 second while in CoMA mode. The CoMA key is solid blue for Keyboard Layer and blinks for Controller Layer. The CoMA Mode key must be blue (or blinking blue) if you want to use the Togl button to switch between Layers.

Channel Rotation off:

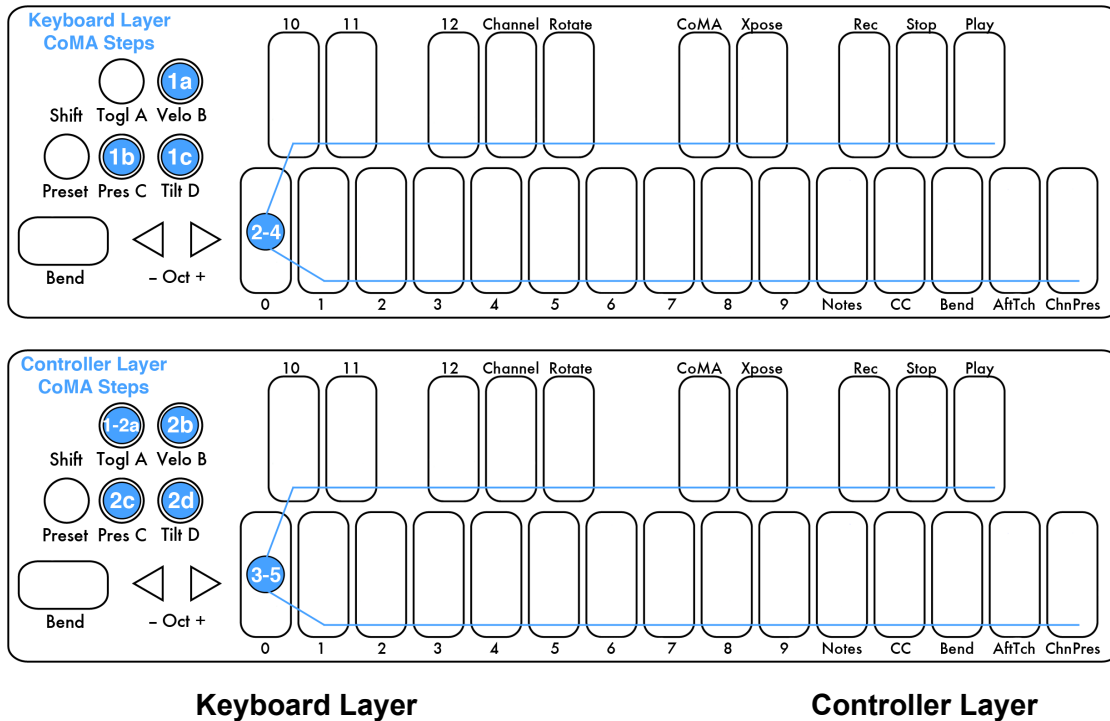

Keyboard Layer

Controller Layer

- After entering CoMA Mode hit the desired source button:
 - “Velo” button for note
 - “Pres” button for pressure
 - skip to step 3
 - “Tilt” button for tilt
 - skip to step 3
 - Hit the desired key to output a Note (use octave buttons to switch octaves if necessary for note mapping).
 - All keys in Keyboard Layer have the same CC#s for Pressure or Tilt, so all you need to do is press the source button to output the MIDI message.
 - The key’s MIDI message will output.
 - If mapping multiple Notes, do so now just by hitting the next key.
 - You can switch sources just by tapping the button for the next source you want to map (see step 1 and repeat).
- After entering CoMA Mode hold the Togl A button for 1 second to map Controller Layer. The CoMA key will flash blue.
 - Hit the desired source button:
 - “Togl” button for toggle
 - “Velo” button for note
 - “Pres” button for pressure
 - “Tilt” button for tilt
 - Hit the desired key (octave buttons don’t apply here because MIDI in Controller Layer doesn’t shift with the octave buttons).
 - The key’s MIDI message will output.
 - If mapping multiple notes or CCs, do so now just by hitting the next key.
 - You can switch sources just by tapping the button for the next source you want to map (see step 2 and repeat).

Channel Rotation on:

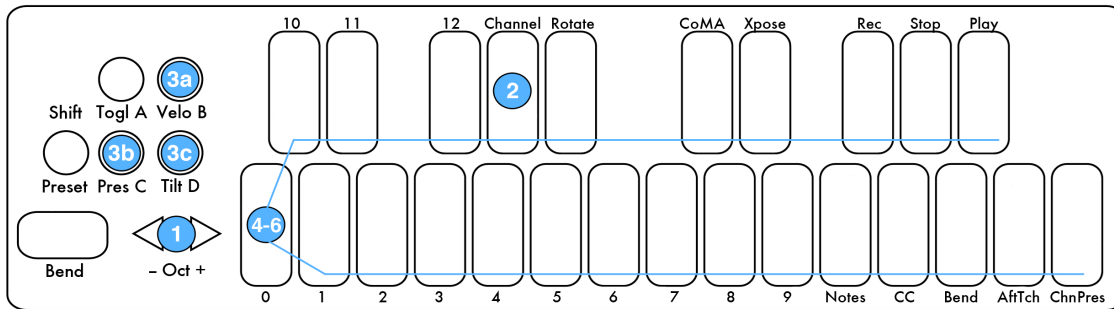

Keyboard Layer

1. After entering CoMA Mode the Channel Key LED will be on, prompting you to enter the Channel number you wish to assign. Select the Channel number using the -Oct+ buttons to increment or decrement to the desired number. The numbered keys display what number you are on as you go.
 - a. Since the QuNexus keys only have number labels up to 12, numbers above 12 in Live Edit Mode are displayed with a solid LED in the tens place and a blinking LED in the ones place.
 - i. Example: If 14, the LED on key 1 will be solid and the 4 key will blink.
2. Hit the Channel Key.
3. Hit the desired Source button:
 - a. “Velo” button for note
 - b. “Pres” button for Pressure
 - i. skip to step 5
 - c. “Tilt” button for Tilt
 - i. skip to step 5
4. Hit the desired key (use octave buttons to switch octaves if necessary for note mapping).
 - a. All keys in Keyboard Layer have the same CC#s for Pressure or Tilt, so all you need to do is press the source button to output the MIDI message.
5. The key’s MIDI message will output.
6. If mapping multiple notes, do so now just by hitting the next key.
7. You can switch sources just by tapping the button for the next source you want to map (see step 3 and repeat).
8. You can switch channels by holding down the Channel key for approximately 1 second (see step 1 and repeat).

Controller Layer

Controller Layer does not rotate channels even when in Channel Rotation Mode so you can use the steps for when Channel Rotation is off (see the previous page).

The **Expression Pedal** does not map in CoMA Mode unless Channel Rotation is on. This is because the Expression Pedal can be mapped outside of CoMA Mode quite easily just by stepping on it. When Channel Rotation is enabled the Expression pedal sends out on all active

Channels. If no keys are held down it will send out on the main starting Channel. If Channel Rotation is on you can map it in CoMA Mode after selecting the Channel (after step 2 from previous page). To map it push it on fully and then push it all the way off.

2.5 Live Edit Mode

Live Edit Mode is mainly intended for making quick edits on the fly. In Live Edit Mode you can turn on and off Channel Rotation, change the MIDI output channel, transpose the keyboard, go into [CoMA](#) mode, turn Channel Pressure and Poly After Touch on and off, set the bend range, and send program change messages. It should be noted that these **edits do not persist** after changing presets or unplugging QuNexus. Any Live Edits will affect **Keyboard Layer only** (not Controller Layer). An illegal entry will just kick you out of Live Edit Mode but any legal entries made prior to that will be kept.

To enter Live Edit Mode hold the Shift button for two and a half seconds until the blue LED on the Shift button turns on and stays lit. To exit just press the Shift button again (you don't have to hold it down to exit).



When you first enter Live Edit Mode you might see that a few of the LEDs on the keyboard turn on. This is because the **ChnPres**, **AftTch**, **CC**, and **Rotate** key buttons all display their state in Live Edit Mode. All four of these are on in the image below:

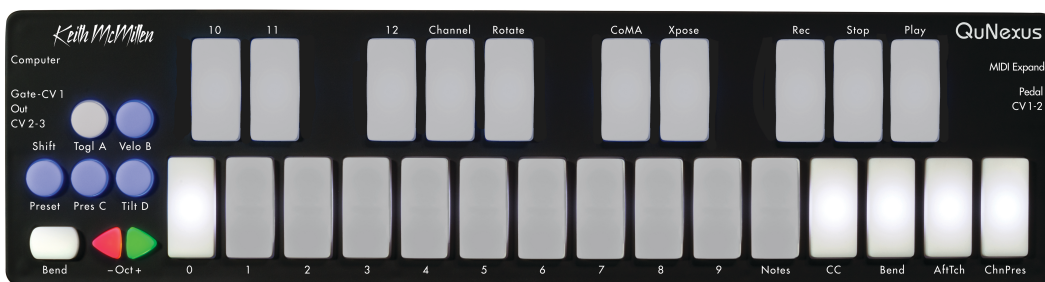

These key buttons act as toggles as well to turn Channel Pressure, Poly After Touch, CCs, and Channel Rotation on and off. Note that if you turn CCs off, all 3 possible CCs from Keyboard Layer will not output unless you turn them back on.

The rest of the things you can do in Live Edit Mode are set up pretty much the same way. Listed below is an outline of the basic steps to edit everything else. Following these steps you can find information that is more specific to each function.

1. Hit the key button associated with what you wish to edit (see details below steps).
2. Use the -Oct+ buttons to increment or decrement to the desired number. The numbered keys display what number you are on as you go.
 - a. Since the QuNexus keys only have number labels up to 12, numbers above 12 in Live Edit Mode are displayed with a solid LED in the tens place and a blinking LED in the ones place.
 - i. Example A: If 16, the LED on key 1 will be solid and the 6 key will blink.
 - ii. Example B: If 112, the LED on key 11 will be solid and the 2 key will blink.
3. Hit the associated button again to accept the edit and move on.

To set the **Polyphony** of the Channel Rotation function, use the “Notes” key with the steps above. The polyphony is how many channels/keys can be used at one time when Channel Rotation is on.

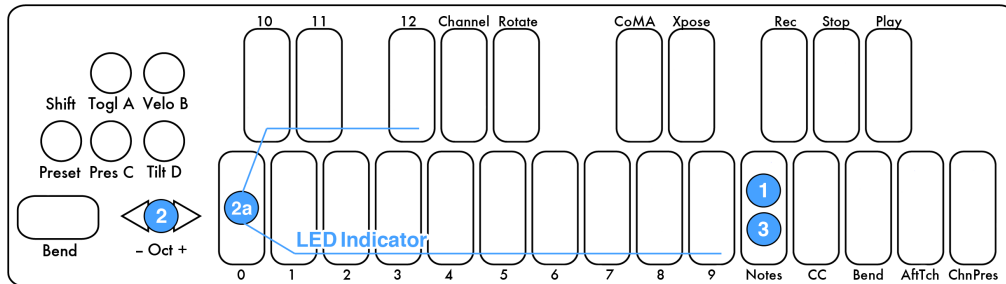

To **Transpose** the QuNexus, use the key labeled “Xpose” with the steps listed above. You can go up or down 11 semitones. If you are below 0 the - Oct button will blink; if you are above 0 the + Oct button will blink.

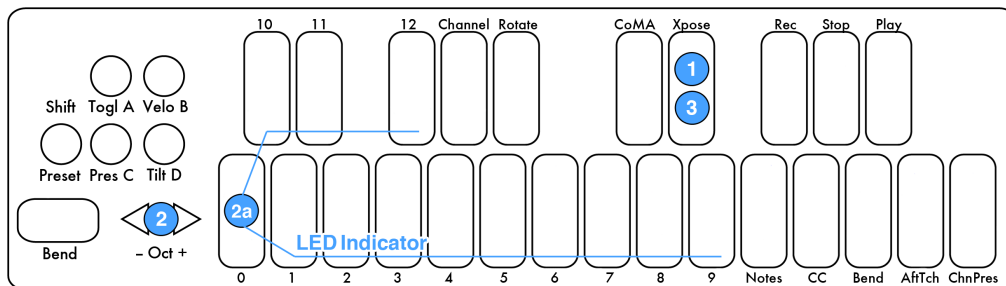

To change the MIDI Output **Channel** number, use the key labeled “Channel” with the steps listed on the previous page (shown below).

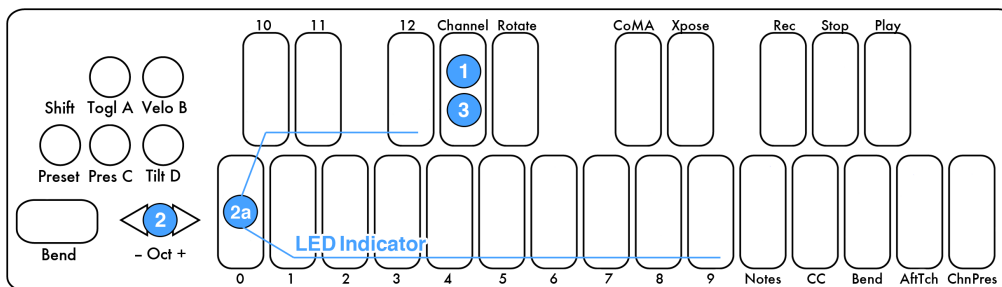

To set the **Pitch Bend Range** use the key labeled “Bend” with the steps listed on the previous page (shown below). You can go from 0 to 12 semitones. If it is set to 0, Pitch Bend will be disabled. The Bend Range will apply to the Bend Pad and also anything set to Pitch Bend in Keyboard Layer.

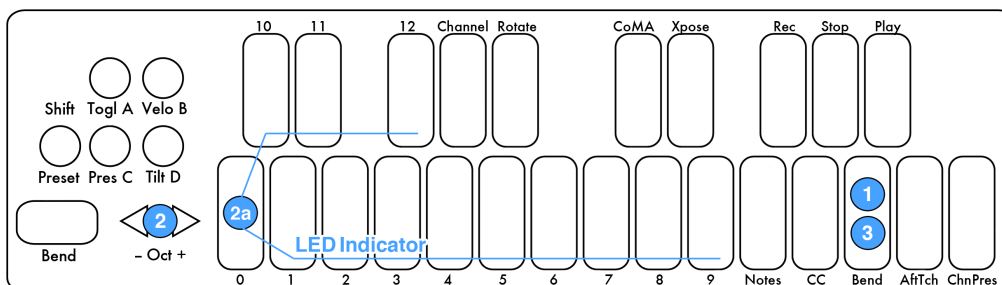

To send **Program Change** messages you don’t have to hit a key button first. The current Preset’s Program Change Number will be displayed when you first enter Live Edit Mode. Use the -Oct+ buttons to increment or decrement to the desired Program Change. The messages will output as you pass them.

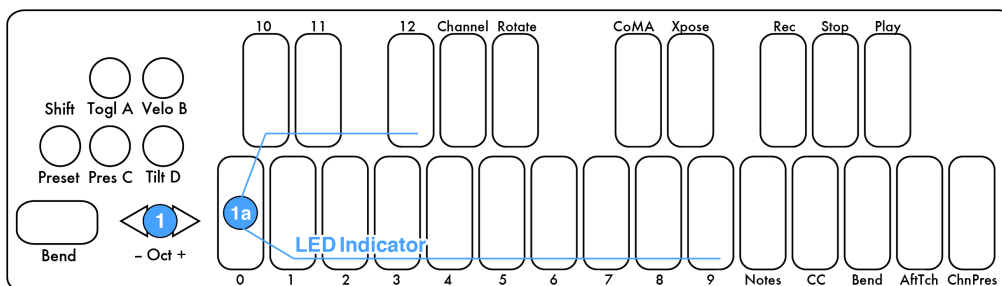

2.6 Controlling LEDs

LEDs can be controlled by sending MIDI Notes through USB Port 1 to the QuNexus. Notes 48 (C2) - 72(C4) will control the keyboard LEDs. If you send notes outside of that range they will wrap around and still control the LEDs of the Keyboard. MIDI Input cannot currently control the Left Side Buttons. Channel 1 is used as the LED Input channel in our Factory Presets (with

exception to Preset D, which uses Channel 9) but the Channel number is editable using the QuNexus Editor. See the [LED Mode](#) chapter for more information.

Chapter 3 QuNexus Editor

The QuNexus Editor is a free application that we provide on our website. It allows you to create customized Presets and load them onto QuNexus. This chapter will guide you through everything you need to know to acquire and operate the QuNexus Editor.

3.1 System Requirements

We recommend the following minimum system requirements for the QuNexus Editor:

MAC:

- An Intel Core 2 Duo 2.3GHz or greater
- Mac OS 10.5 or later
- 50MB free hard disk space

WINDOWS:

- Windows XP, Windows 7 & 8
- Intel Core 2 processor or greater
- 1GB of RAM with 50MB free hard disk space

3.2 Installing the Software

For those who wish to customize QuNexus, download our free QuNexus Editor Installer from: <http://www.keithmcmillen.com/QuNexus/downloads/>. This comes with the QuNexus Editor and Documentation.

Installer Instructions (Mac)

1. Double-click on the .dmg file to open the disk image, and then drag the QuNexus directory into the Applications Alias.
2. A QuNexus folder will now appear in your Applications folder.

Installer Instructions (Windows XP, 7, & 8)

1. Extract the directory from the .zip file and place at a location of your choosing.
2. In order for the application to access everything it needs to run, do not move anything out of the directory.

3.3 Updating the Firmware

Make sure the editor and the firmware versions are compatible with each other.

When the QuNexus Editor opens, it checks to make sure the firmware on the device is compatible with the application. If the firmware is not compatible, an update prompt will appear. Click ok and wait until the blue Shift button light stops flashing. The blue light and progress bar on screen indicate that the firmware update is in progress.

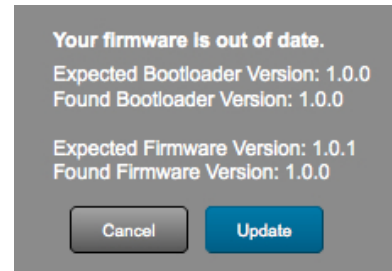

An “Update Firmware” option is located in the Hardware Menu of the QuNexus Editor. Select this option to force a firmware update.

Keith McMillen Instruments cannot be held liable for damage resulting from installation and operation errors or improper use.

3.4 Main Window Overview

The QuNexus Editor opens with this window:

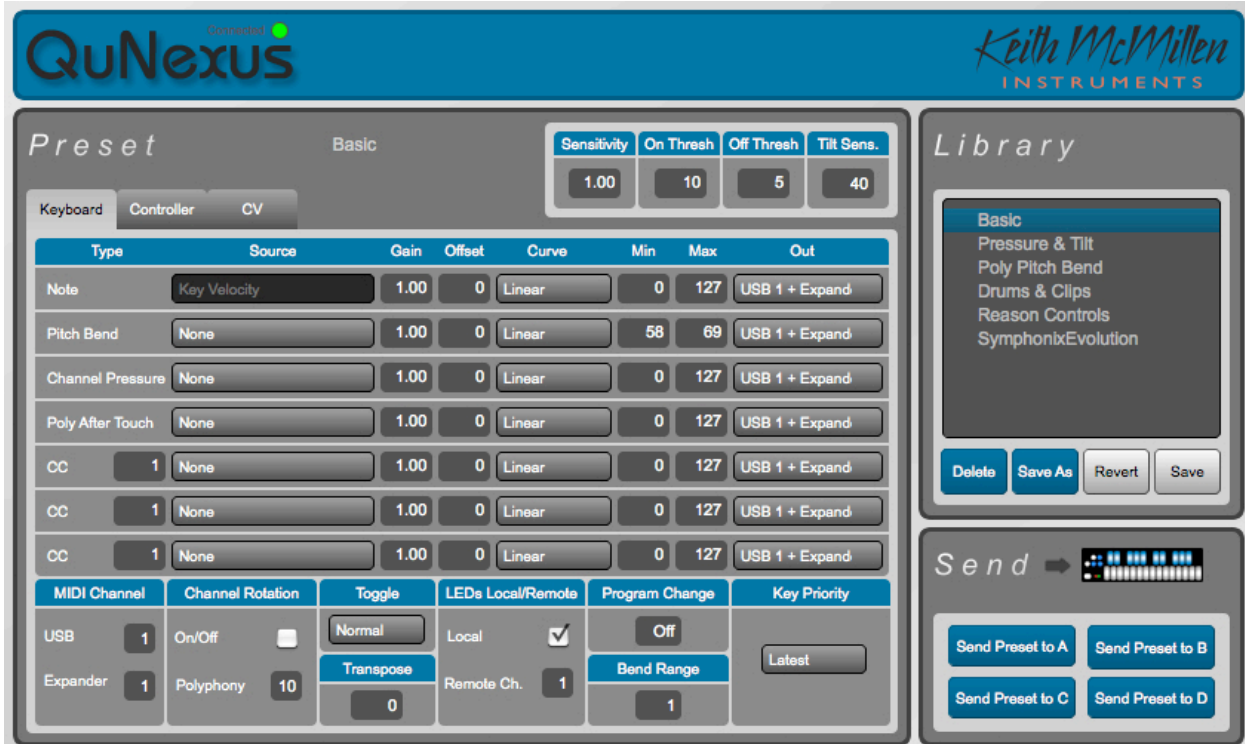

Customize the QuNexus output and input using the Keyboard, Controller, and CV tabs (Layers).

Just above the right side of the tabbed box are the global sensitivity settings to control Gain, On Threshold, Off Threshold, and Tilt Sensitivity for the QuNexus keys. Controls for saving and recalling presets are found on the right side of the window. There are tabs for editing Keyboard Layer, Controller Layer, and CV Layer. Keyboard Layer is the main space for editing the behavior of the keyboard. Controller Layer allows you to assign additional Notes and individual Pressure and Tilt CC#s for each Key. CV Layer is for editing the CV input and output.

3.5 Saving Presets

Select presets by clicking on them in the Library. There are four Factory Presets. See [Factory Presets chapter](#) for descriptions of the first four, which come already loaded onto the QuNexus. See below for descriptions of the Reason and SymphonixEvolution presets.

After clicking a Preset, the name of it will appear above the tabs. Now you can make changes to the Preset. The Preset name will turn red and an asterisk will appear next to it to indicate it has unsaved changes. You can use the **Revert** button or the **Save** button under the Preset Library to discard or keep your changes. The Revert button will go back to the previously saved version of the preset.

The **Delete** and **Save As** buttons under the Preset Library allow you to add or remove presets. Copy/Add a Preset by first selecting the preset you wish to copy and then clicking the **Save As** button. You can name it and it will be added to the bottom of the Library.

To send any of the Presets in the Library down to the QuNexus, click on the Preset in the Library and use the buttons in the Send box (shown to the right) to send it to any of the four Preset slots. If the Preset has any unsaved changes you must save them before sending them to the QuNexus. The Library will display which Presets are in which slots on the QuNexus.

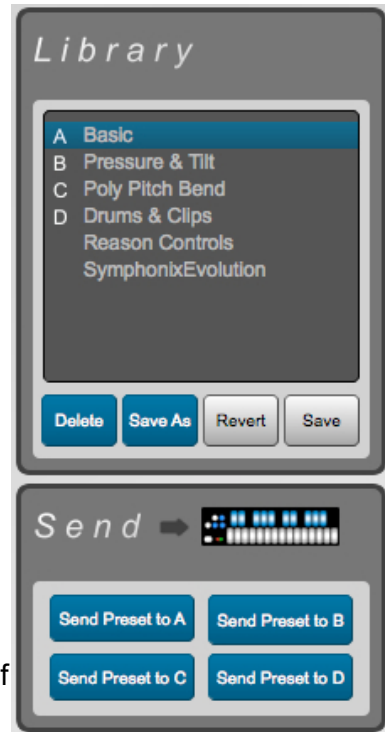

For information about how to select presets on the QuNexus see the [Selecting Presets chapter](#).

The Reason Controls and SymphonixEvolution preset are included in the preset library for use with Reason and Symphonix Evolution for iPad.

Reason Controls - Propellerhead's Reason 7 in equipped with a QuNexus Control Surface Mapping. Using this will automatically map QuNexus to various Synthesizer controls within Reason.

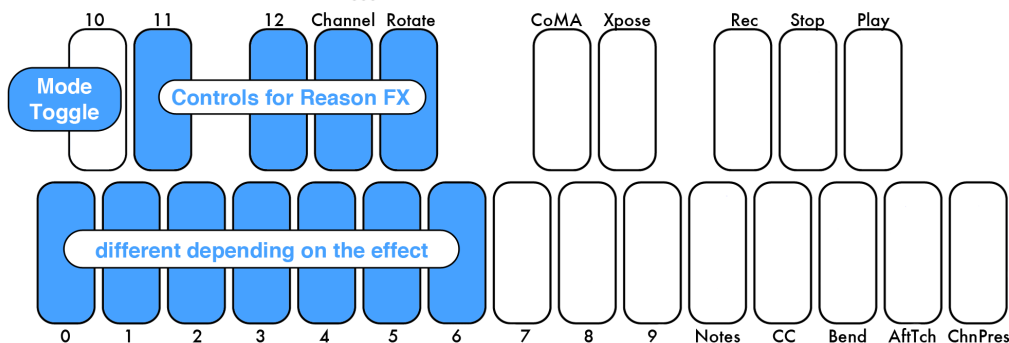

The top octave is for playing melodies. Pressure controls modulation and Tilt controls Pitch Bend. The lower octave (shown in blue) control FX parameters in the Reason Instruments.

These will control something different depending on the Instrument used. The C# key in the lower octave acts as a toggle between modes. In the first mode the keys in the lower octave will control different parameters than in the second mode. For more information on using this preset with Reason, refer to the QuNexus Reason Quickstart document.

SymphonixEvolution - Symphonix Evolution is a keyboard/synth app for iPad. Use this preset to extend the functionality of QuNexus with Symphonix Evolution.

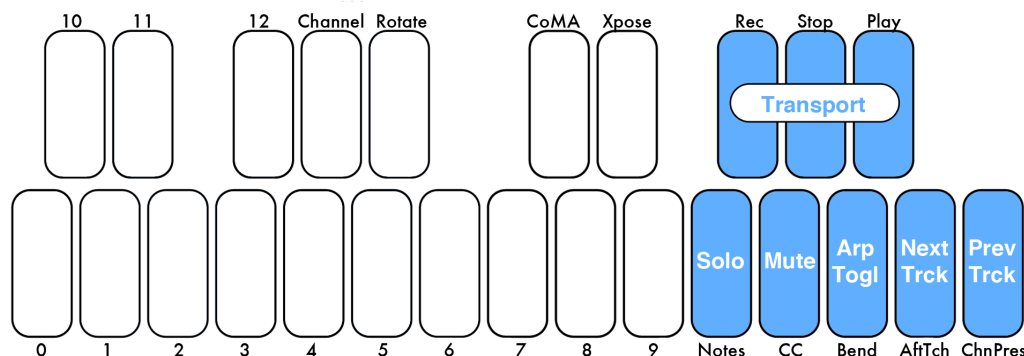

The top 8 keys on QuNexus will control transport, the arpeggiator, track selection, mute, and solo (shown in blue). The other keys (shown in white) can be used for playing melodies. These keys also use Pressure to control modulation and tilt to control pitch bend. The Expression Pedal controls Playback Position. For more information on using this preset with Reason, refer to the QuNexus Symphonix Evolution Quickstart document.

3.5.1 Importing and Exporting Presets

Import and Export Presets using the commands in the File Menu. **Import Preset** lets you select a previously exported preset and load it to a new slot. **Export Preset** will save a file containing the currently selected preset to a location of your choice on your hard drive for safe keeping or sharing. Importing and Exporting makes preset sharing easy.

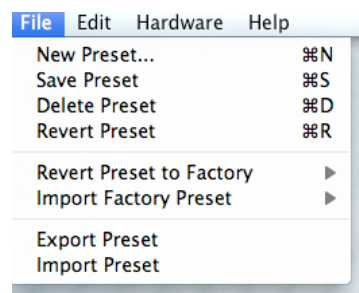

3.6 Menu Bar

The QuNexus Editor's Menu Bar contains several useful features.

The File menu duplicates the **New**, **Save**, **Delete**, and **Revert Preset** functions from the Preset Library box, assigning them shortcuts to add convenience.

You can also Revert or Import Factory Presets.

Revert Preset to Factory causes the currently preset parameters to change to the Factory Preset selected from the menu. The name will not change.

Import Factory Preset will create a new slot with the original Factory Preset.

See the [Importing and Exporting Presets](#) chapter for more information about the other File menu items.

The Edit menu contains several copy/paste functions. In Controller Layer you can highlight a key, copy it by going to **Copy Controller Sensor**, highlight another key, and paste by going to **Paste Controller Sensor**.

You can also use the items within the **Copy/Paste Layer** submenu to copy and paste entire layers to other Presets. Select a Preset and use the menu options to copy its Controller Layer, Keyboard Layer, or CV Layer. Then go to a different Preset and paste the corresponding Layer.

The Hardware menu includes an option to force a Firmware update. If the connected QuNexus' firmware is already up to date it will just re-upload the same firmware. If not the QuNexus should automatically prompt you for an update when you open the Editor.

Here you can also select an **LED Refresh Mode** for your preset:

Normal - LEDs behave normally, lighting up and responding to Remote LED messages as expected.

Control Only - Only the LEDs on the Side Buttons will light up. The Keyboard LEDs will not light when touched or respond to Remote LED Control. LEDs will still light up normally in Preset Select and Live Edit Modes.

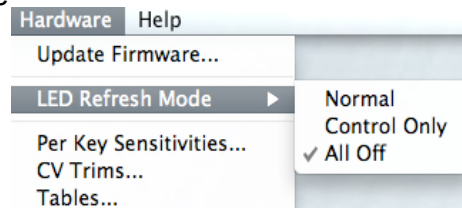
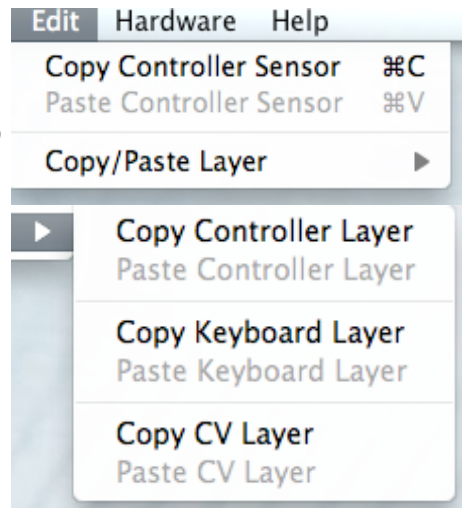
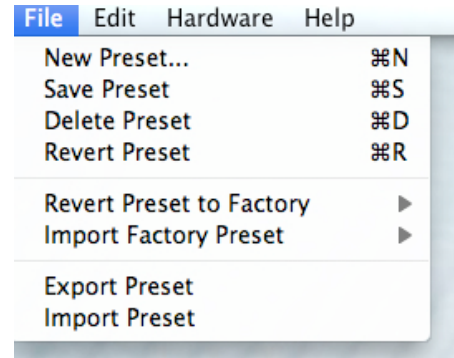

All Off - None of the LEDs will light. The Keyboard LEDs will not respond to Remote LED Control. LEDs will still light up normally in Preset Select and Live Edit Modes.

LED Refresh Mode saves in the preset so make sure to save and send your preset to QuNexus in order for this option to take effect. All of the Factory Presets use Normal mode.

For information about the **Per Key Sensitivities** option see the [Per Key Sensitivities](#) chapter.

For information about the **CV Trims** option see the [CV Trims](#) chapter.

For information about the **Tables** option see the [View/Edit Tables](#) chapter.

The Help menu's **Documentation** will open the QuNexus Manual.

There is also an option to Hide or Show Tool Tips. **Tool Tips** are quick, helpful descriptions that pop up if the mouse hovers over certain parameters in the Editor. Not all parameters have Tool Tips.

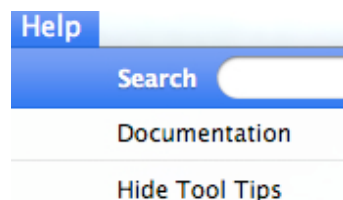

3.7 Sensitivity



There are Sensitivity controls just above the tabs. Here you can adjust the Sensitivity, On and Off Thresholds, and the Tilt Sensitivity. These are global for the entire keyboard but can be set differently for each preset.

Sensitivity controls how easy it is to get higher value ranges when controlling pressure and velocity. The higher the sensitivity, the easier it will be to reach the upper range of values. The lower the sensitivity, the more difficult or impossible it will be to get higher value ranges.

On Thresh controls the pressure value at which a note on will register. Example: If set to 10, the Slider pressure has to reach a value of 10 before a note on is sent.

Off Thresh controls the pressure value at which a note off will register. Example: If set to 5, the Slider pressure would have to be 5 or lower for a note off to register. This cannot be set higher than the on threshold.

Tilt Sens. controls how easy it is to activate the Tilt source. By default, Tilt requires an intentional pressure shift/tilt of your finger to engage. This makes it easier to activate Tilt only when you want to. The higher the value of Tilt Sens., the easier it is to activate Tilt.

3.7.1 Per Key Sensitivities

It is possible to adjust the sensitivities of each key individually. To do this go up to the menubar and select **Hardware** and choose **Per Key Sensitivities...**

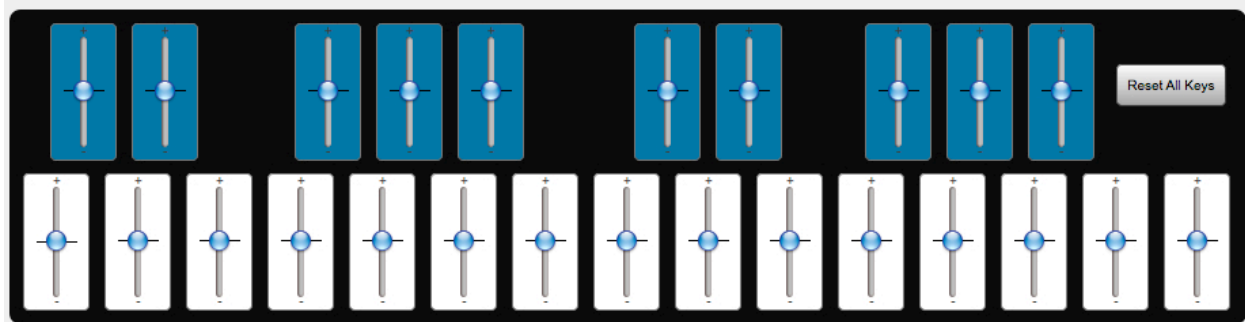

The above window will open. Use the sliders to make adjustments to the sensitivities of specific keys. Move the slider up to make the key more sensitive or down to make it less sensitive.

Adjustments made here are added to the sensitivity setting in the main window. So adjustments can be made in both places and neither will override the other.

The **Reset All Keys** button will return all keys to their center positions.

The settings in the Per Key Sensitivities window are not saved per preset. They are applied globally for all presets and are sent down to QuNexus as you adjust them in real time.

3.8 Keyboard Layer

Type	Source	Gain	Offset	Curve	Min	Max	Out
Note	Key Velocity	1.00	0	Linear	0	127	USB 1 + Expand
Pitch Bend	Tilt	1.00	0	Linear	53	74	USB 1 + Expand
Channel Pressure	None	1.00	0	Linear	0	127	USB 1 + Expand
Poly After Touch	None	1.00	0	Linear	0	127	USB 1 + Expand
CC	1 Pressure	1.00	0	Linear	0	127	USB 1 + Expand
CC	1 None	1.00	0	Linear	0	127	USB 1 + Expand
CC	1 None	1.00	0	Linear	0	127	USB 1 + Expand
MIDI Channel	Channel Rotation	Toggle	LEDs Local/Remote	Program Change	Key Priority		
USB 1	On/Off <input type="checkbox"/>	Normal	Local <input checked="" type="checkbox"/>	Off	Latest		
Expander 1	Polyphony 10	Transpose 0	Remote Ch. 1	Bend Range 2			

Here you can choose how the QuNexus keys output MIDI. Start with what type of MIDI data you want, go across the row, and end with the output destination (USB, Expander, or USB + Expander). For example, if you want to add Pitch Bend to your keyboard follow these steps:

1. Find Pitch Bend in the first column.
2. Go across the row and select the desired source in the second column (like tilt).
3. Use the math modifications (Gain, Offset, Curve, Min, and Max) if you wish to, or leave them the same if you don't wish to alter the MIDI output values.
4. Select what MIDI output you wish to use in the final column (USB, the MIDI Expander, or both).

The following subchapters will go into detail for each column one at a time:

3.8.1 Types

Note: This type is the note velocity that each key will use to output with the Note. Velocity simulates the way a piano gets louder as the keys are struck with greater force. So the higher the velocity values (0-127) are, the louder the MIDI notes will sound. This type is set to always use Key Velocity as the source.

Pitch Bend: Each note can bend its pitch using this type. Pitch bend is currently 7 bit. The bend range in part depends on the MIDI device used for output but is also settable on our end using the Bend Range box (see [chapter 3.8.11](#) for more information).

Channel Pressure: The Channel Pressure message is for sending a continuous pressure value (from 0-127) for the entire keyboard (an average of the pressure of all keys on one channel). Not all MIDI devices can interpret Channel Pressure so make sure to check the device or software you are working with.

Poly After Touch: This is for sending a continuous pressure value (from 0-127) after a note on for each key individually.

CCs: Stands for Continuous Controller. There are 4 rows to allow the use of 4 different CC numbers. This MIDI format contains a controller number and a 7 bit value (0-127). It is often used to control miscellaneous parameters like distortion amount or the volume of a mixer channel.

3.8.2 Sources

Key Velocity (for notes only): The value between 0 and 127 that represents the overall pressure on the QuNexus keys at the moment a note on (or finger on) is detected. Sensitivity can be adjusted using the Sensitivity number box above the tabbed box.

Pressure: Continuous values (between 0 and 127) represent the applied pressure of your finger on the QuNexus keys.

Tilt: Continuous values (between 0 and 127) represent the tilt of your finger on the QuNexus keys. When released the value goes back to center (63). By default, Tilt requires an intentional pressure shift/tilt of your finger to engage. This makes it easier to activate Tilt only when you want to. You can increase the sensitivity of the tilt activation pressure by increasing the value in the Tilt Sens. number box above the tabbed box.

Expression Pedal: When an expression pedal is plugged into the CV input of QuNexus, the expression pedal data will be converted to MIDI and go from 0 - 127. When Channel Rotation is enabled the Expression pedal sends out on all active Channels. If no keys are held down it will send out on the main starting Channel.

3.8.3 Gain, Offset, Curve, Min, and Max

After selecting your source for the MIDI data type, you can then further modify what values you are sending to your MIDI device/software by using the math modifiers in the next five columns.

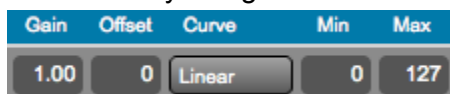

Gain: The number in the gain box is used to multiply the raw value coming from the source. For example, setting the gain number box to “2” will double whatever value is received from the source. Setting the gain box to 0.5 will cut the value from the source in half.

Offset: The offset is added onto the raw value after it has been multiplied by the gain value.

Curve: The result after the offset is entered into the selected curve’s lookup table and used to plot the index on a chart. There are a number of table options, each which will affect the value differently as it increases or decreases. The shape of each curve is pictured below:

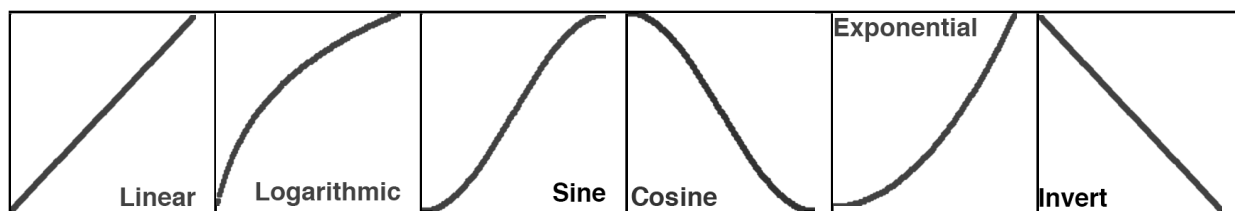

There are two user table options that are settable from the View/Edit Tables window that you can access from the Edit Menu. See the [View/Edit Tables](#) chapter below for more information on setting the User Tables.

Min and Max: These allow the value to be constrained between a minimum and a maximum number. If the min is set to 10 and the max is set to 15, then the output cannot be less than 10 or more than 15. Anything outside the range of the min and max will be truncated. Note offs will still be at velocity 0 even if the min is set above 0.

Example: If I want Channel Pressure to control a Filter cutoff but only span half the range of the filter I could do this two different ways:

1. Set the Channel Pressure Gain to .5 so that you only get half the values. If you wanted to get the top half of the filter you could set the offset to 63. This would allow you to output a pressure of 63-127 to the filter.
2. Set Min to 63 and keep Max to 127. This allows an output of 63-127.

While both methods work and set the same range of output values, the first method is probably a better way to achieve these results. This is because the second method ignores and truncates the first half of the pressure of your finger on the key. The first method scales the range so that the whole range of motion is used.

3.8.3.1 View/Edit Tables

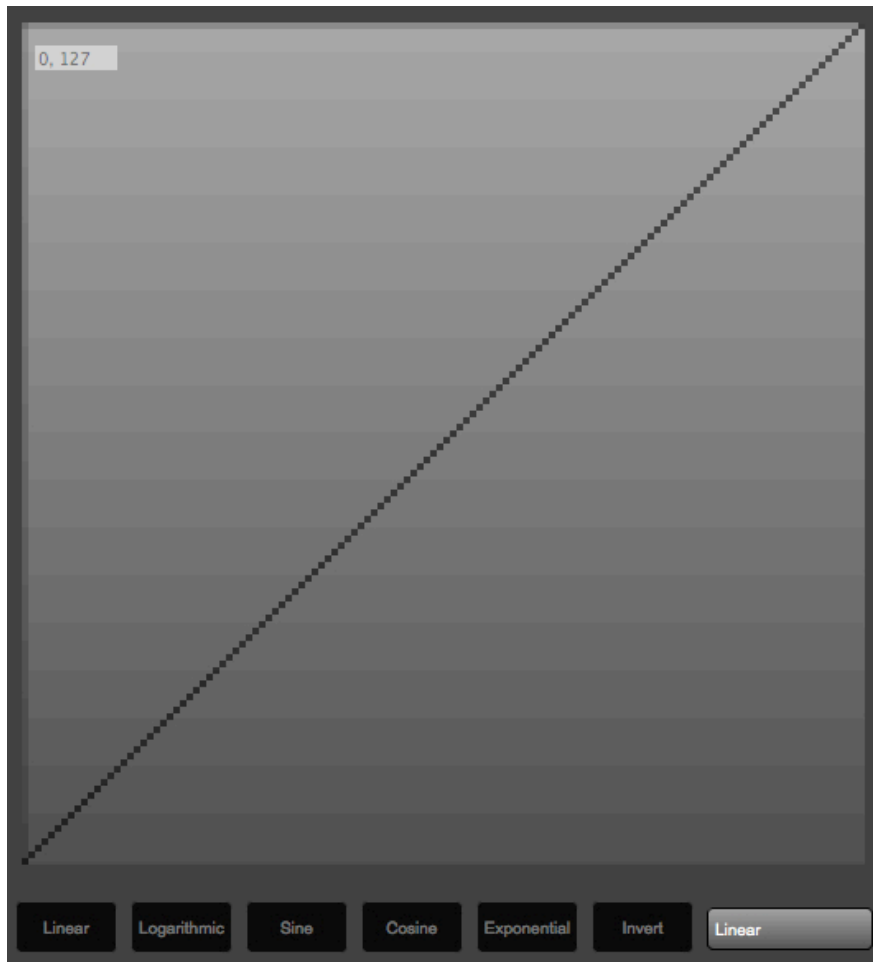

The Tables window is accessible from the Hardware Menu. When you first open it you will see the window shown above.

You can select a table to view in the menu in the bottom right corner. If you select "Custom 1" or "Custom 2" the tables become editable.

When the table is editable, the line will turn green (as shown in the image to the right). You will be able to click the buttons along the bottom of the window to start with one of the other curves.

To use one of the Custom Tables, you must make sure to select "Custom 1" or "Custom 2" in the Curve column of Keyboard Layer or CV Layer.

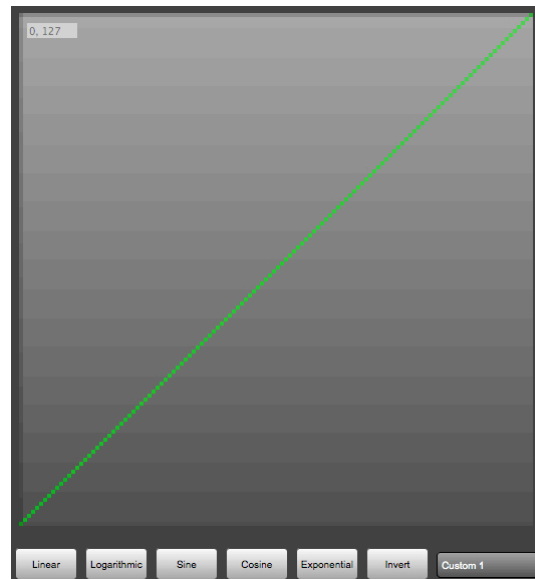

3.8.4 Out

The possible output destinations for the MIDI data results are:

USB: MIDI goes from the QuNexus keyboard to an attached computer through USB Port 1.

Expander: If a KMI MIDI Expander is attached, the MIDI data will go out the Expander's 5-pin MIDI Out port.

USB + Expander: MIDI data goes out the KMI MIDI Expander's 5-pin MIDI Out port and to a computer through USB port 1.

3.8.5 MIDI Channel

Set the output channels in the MIDI Channel box in the bottom left corner. There can be separate USB and MIDI Expander Channels. If Channel Rotation is on then the Channels set in this box act as the starting channel (see the [Channel Rotation](#) chapter for more information).



It is also possible to change your MIDI Channel on the fly using Live Edit Mode. See the [Live Edit Mode](#) chapter for more information.

3.8.6 Channel Rotation

Channel Rotation is a feature that causes the order of keys pressed at one time to rotate through channels. For example, the first pressed key's MIDI data from Keyboard Layer goes out Channel 1, the second pressed key's data goes out Channel 2, the third pressed key's data goes out Channel 3, etc. Release those keys and you will start over on Channel 1 next time you press a key. This feature is useful for getting a different pitch bend, channel pressure, or poly aftertouch for each note as opposed to one for all notes.

The polyphony number sets how many channels/keys can be used at one time. Adjust the MIDI Channel to change the starting channel.



Both the polyphony number and the MIDI Channel can be changed on the fly using Live Edit Mode. See the [Live Edit Mode](#) chapter for more information.

3.8.7 Toggle

The Toggle box includes a menu to select between Off, On, and Legato. Below are descriptions of each setting:



Off - Toggle Mode will initialize as off. Pressing a key sends a note on, releasing the key sends a note off.

On - Toggle Mode will initialize as on. Pressing a key sends a note on, a second press on the same key turns that note off. Pressing a different key sends a note on without turning off the previous key. Tap the Togl A button on the left side of the QuNexus to clear all notes. The LEDs will display which keys are “on”.

Legato - Legato Mode will initialize as on. Pressing a key sends a "note on" but releasing doesn't send a note off. When a different key is pressed, the previous note is turned off and the new note is turned on. Tap the Togl A button on the left side of the QuNexus to clear a note without having to hit the next one.

Hold the Togl A button for approximately 1 second to turn Toggle (or Legato) mode on and off. All the Factory Presets initialize with Toggle off and do not use Legato mode. If you are using a custom preset, the Togl A button's blue state will indicate that either Toggle or Legato is on (depending on which you have selected in the preset).

Toggle in Keyboard Layer is separate from the toggle behavior available in Controller Layer. See [Controller Layer Toggle](#) for more information.

3.8.8 Transpose

The Transpose value represents the number of semitones to transpose the keyboard up or down.



The Transpose value can also be changed on the fly using Live Edit Mode. See the [Live Edit Mode](#) chapter for more information.

3.8.9 LEDs Local/Remote

The LED Mode box allows you to turn off Local LED Control. Local LED Control is the QuNexus' built-in LED behavior. Without sending LED messages to the QuNexus from another application or device, the QuNexus' LEDs will automatically respond to touch.



There is also a number box for selecting which MIDI Channel the LEDs respond to when sending Remote LED Control Notes to the QuNexus on USB Port 1.

Remote LED Control is always allowed but if Local LED Control is enabled, the LEDs will prioritize the Local LED Behavior. So if you've sent a Remote LED Note on message to a key and then touch and release the same key, the LED will turn off. This is because when you released the Note the Local LED behavior turns the LED off.

See the [Controlling LEDs](#) chapter for more information about Remote LED Control.

3.8.10 Program Change

Here you can set the Preset to use a Program Change Message. This will cause the QuNexus to output the Program Change value every time that preset is selected from the QuNexus. See the [Selecting Presets](#) chapter for more information. Program Changes can be useful for changing presets on a synth.



3.8.11 Bend Range

Here you can set the Range of semitones for Pitch Bend. This should alter the Min and Max setting of the Pitch Bend line above.



The Bend value can also be changed on the fly using Live Edit Mode. See the [Live Edit Mode](#) chapter for more information.

3.8.12 Key Priority

This selection box assigns which keys pressed will have control over the tilt, channel pressure, poly aftertouch, and other sources of Keyboard Layer. The options are Latest, Earliest, Highest, and Lowest. Whichever option is selected indicates the key that will have the control. For example: if "Latest" is selected, the last key pressed will have control over Pitch Bend if Pitch Bend is set to Tilt (or Pressure).



3.9 Controller Layer

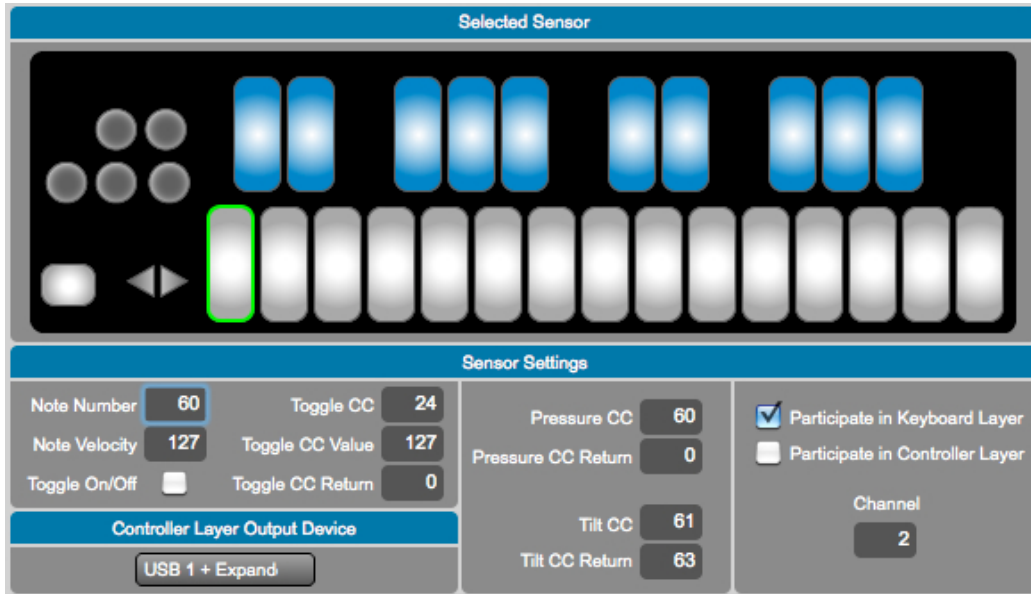

The Controller Layer tab appears next to Keyboard Layer. Here you can assign each key its own additional Note, Toggle CC#, Pressure CC#, and Tilt CC#. Do this by clicking on any key in the image so that it is highlighted with a green border. Then look below the image at the Sensor Settings.

Tip: CV Layer does not convert MIDI Messages from Controller Layer.

3.9.1 Sensor Settings

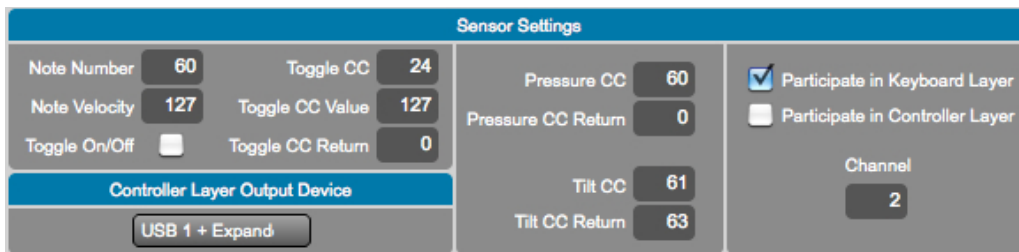

Here you can decide what to enable for the highlighted Key. There are number boxes for choosing which Note Numbers and CCs to use and what their behavior will be. You can choose whether the key participates in Keyboard Layer, Controller Layer, or both. You can also set the Channel number and the output device.

3.9.1.1 Participate

There are two “Participate” checkboxes on the right side of Controller Layer’s Sensor Settings, one for Keyboard Layer and one for Controller Layer. These allow you to isolate specific keys for controller use only, keyboard use only, or both.

If **Participate in Keyboard Layer** is disabled, the selected key will no longer play its regular note or contribute to controlling Channel Pressure, Poly After Touch or anything else that might have been set up in the Keyboard Layer tab. Local LED behavior will also turn off for that key, meaning the keys will not light up when pressed (it can still receive Remote LED messages and if Controller Layer Toggle is enabled, the LEDs will still show the toggle state). The Octave buttons will no longer do anything since they only raise and lower the octave of the notes in Keyboard Layer.

If **Participate in Controller Layer** is disabled, nothing you do here in Controller Layer will have an effect on the selected key. Enabling it allows the assigned Note, Toggle CC, Pressure CC, and Tilt CC numbers to output.

If **both Keyboard Layer and Controller Layer are enabled**, the selected key will send out everything that you have assigned it here in Controller Layer Tab and also in the Keyboard Layer Tab. For **Example**: if you turn Channel Pressure on and Pitch Bend set to Tilt in Keyboard Layer and have all 4 sources on in Controller Layer, then that Key will send out 2 notes, Channel Pressure, Pitch Bend, and CC values for an additional Pressure, Tilt, and Toggle source. Controller Layer assignments will not increment or decrement when using the -Oct+ buttons. Neither will they Rotate Channels if Channel Rotation is enabled in Keyboard Layer.

3.9.1.2 Controller Layer Sources

Now it is established that it is necessary to enable “Participate in Controller Layer” for any keys you wish to assign Controller Layer Notes or CC#s to. Controller Layer has 4 sources of its own that can be assigned per key: Notes, Toggles, Pressure and Tilt. Use the **Note Number**, **Toggle CC**, **Pressure CC**, and **Tilt CC** number boxes to set which Note number or CC number the selected key will use for each source. Setting these number boxes to “-1” will turn the sources off.

Under the Pressure and Tilt CC number boxes are the **Pressure CC Return** and the **Tilt CC Return** number boxes. These set what values the Pressure and Tilt CC#s will return to when released. So if the Tilt CC Return box is set to 63, when you release the key the tilt source will go to 63. Tilt and Pressure can also latch; if the Return boxes are set to “-1” (“latch”), then they will stay at the value when they are released.

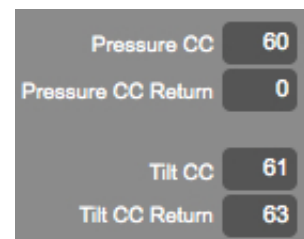

Specify Controller Layer’s Note Velocity with the **Note Velocity** Number box. Set this number box to “-1” (“var”) to turn velocity response on and allow it to vary depending on pressure.

3.9.1.3 Controller Layer Toggle

Note Number	48	Toggle CC	24
Note Velocity	127	Toggle CC Value	127
Toggle On/Off	<input type="checkbox"/>	Toggle CC Return	0

There is a dedicated CC# for Toggling in Controller Layer. This has nothing to do with the Toggle options in Keyboard Layer. In fact, you must disable “Participate in Keyboard Layer” in order to use the Toggle CC#. This is because Keyboard Layer has it’s own built in Toggle behavior which cannot interact with Controller Layer’s Toggle.

With Keyboard Layer disabled, to use toggle in Controller Layer, turn the **Toggle On/Off** check box on and set the Toggle CC, Toggle CC Value, and Toggle CC Return parameters.

Toggle CC - This is where you choose which CC number will toggle.

Toggle CC Value - This represents the CC value that will output when the Toggle state is ON.

Toggle CC Return - This represents the CC value that will output when the Toggle state is OFF.

Any Notes assigned on the same Controller Layer key with Toggle enabled will toggle with the CC number. The **Note Velocity** number box will be the velocity that outputs when the Toggle state is ON. The LEDs will indicate the toggle state.

3.10 CV Layer



Here you can choose how the QuNexus keys send and receive CV (Control Voltage). QuNexus has 4 possible CV outputs and 2 possible CV inputs (see the [CV chapter](#) for the hardware specs).

There is a box labeled **Gate S Trig** in the upper right corner; if this is checked, the gate output will be inverted so that gate on is 0V and gate off is 5V. Some older synthesizers use this paradigm. Please consult the technical specifications of your synthesizer if you are unsure which gate signal it needs.

The box to the left of Gate S Trig is the **Gate Legato** box; if this is checked, the gate output will not iterate an off state between notes.

You can set the **Pitch Scaling** Scheme in the box to the left of the Gate Legato box. You can set this to 1 Volt per Octave, 1.2 Volts per Octave, or Hertz per Volt (an older scaling scheme).

3.10.1 CV Output (MIDI to CV)

The MIDI to CV table has 4 rows (1 for each CV output) and 9 columns. Start with what MIDI Device Input you are using, go across the row, and end with the CV output destination (Gate, CV 1, CV 2, or CV 3). For example, if you want Pitch Bend Data from the MIDI Expander to go out CV 1 follow these steps:

1. Locate the Row used for CV 1 (second row).
2. Select Expander as the MIDI Device Input.
3. Choose the MIDI Channel whose Pitch Bend data you wish to use.

4. Select Pitch Bend as the MIDI Type in column 3.
5. Use the math modifications if you wish to, or leave them the same if you don't wish to alter the data output with math.

Tip: The Channel parameter here in CV Layer is used only for messages coming from the USB Ports, not the keyboard itself. The CV outputs will use MIDI notes from Keyboard Layer regardless of the Channel. Whatever the Key Priority in Keyboard Layer is set to will be the note that CV sends out (see the [Key Priority](#) chapter for more information).

3.10.2 CV Input (CV to MIDI)

The CV to MIDI table has 2 rows (1 for each CV output) and 9 columns. Start with what CV input you are using, go across the row, and end with the MIDI Device the converted MIDI Data will be sent to (Expander, USB 3, or USB 3 + Expander). For example, if you want to convert an Expression Pedal to control CC# 7 on Channel 1 for a device connected to the MIDI Expander follow these steps:

1. Choose the row for CV 1 or CV 2.
2. Select the MIDI Channel to convert the CV to.
3. Select the CC # to convert the CV to.
4. Use the math modifications if you wish to, or leave them the same if you don't wish to alter the MIDI output with math.
5. Select which MIDI device to output the data to (MIDI Expander, USB 3, or USB 3 + Expander).

3.10.3 CV Trims

The CV Trims window is accessible from the Hardware Menu. When you click CV Trims in the menu the window to the right will appear.

This window provides a way to compensate for an out of tune synthesizer by allowing you to adjust the QuNexus' tuning for each pitch scaling mode. Use this only if you are unable to adjust the tuning from the synthesizer itself.

Increasing the Trim and offset will raise the pitch of your synth, while decreasing the values will lower the pitch.

The settings in the CV Trims window are not saved per preset. They are applied globally for all presets and are sent down to QuNexus as you adjust them in real time.



Chapter 4 Troubleshooting

If you are having trouble of any kind make sure you double check the following before moving on to the chapters below that address specific problems:

1. With your QuNexus plugged in check Audio MIDI Setup's MIDI view (**Mac** only) and make sure QuNexus' icon is active (not grayed out). Or open up the QuNexus Editor (**Mac or Windows**) and make sure it says "Connected" just above the QuNexus logo. If not, try these:
 1. Unplug your QuNexus and plug it back in.
 2. Unplug your QuNexus, restart your computer, and plug your QuNexus back in.
 3. Try a different USB cable.
2. Make sure you are using the correct firmware. When the QuNexus Editor opens, it checks to make sure the firmware on the device is compatible with the application. If the firmware is not compatible, an update prompt will appear. Click update.

If you experience any problems or have questions regarding the QuNexus install process after viewing all of the troubleshooting suggestions, submit a support request (<http://www.keithmcmillen.com/support>) outlining the problems you're experiencing. The more detailed you are in describing your problem (information about your computer, the software you're running, the circumstances around the issue), the more easily we will be able to help you. To make things much faster it is helpful if you include the following when submitting a support question:

1. Your operating system
2. Your computer's specs (processor speed, amount of RAM, etc)
3. Firmware version on your QuNexus
4. Version number of the QuNexus Editor you are using
5. A detailed description of your problem
6. Steps taken to produce this problem
7. Steps you have taken to try and solve your problem

Also, please think about whether or not your question is actually a QuNexus question or a question about the software you're using your QuNexus with.

4.1 Connectivity Trouble

If you are having trouble establishing a stable connection between your QuNexus and your computer, iPad, MIDI, or CV Device then this chapter should help. Make sure you read the [Connecting QuNexus](#) chapter above first to be certain that you are connected correctly.

4.1.1 Touchy USB Connection

If your QuNexus is powering on and off with just the slightest touch of the USB cable, or the QuNexus itself, then you likely have a less than stellar cable. It may seem that it's the USB port on the QuNexus causing this, but it really is much more likely to be the cable's fault. We have yet to see a QuNexus with a faulty USB port (though not to say that this is impossible).

Solution:

Replace your USB cable!

If you received a faulty cable with your QuNexus, please submit a support ticket to KMI tech support (<http://www.keithmcmillen.com/support/>) and we can get you a replacement. Or if you'd rather not wait and would like to just go out and get one yourself, most retail stores carry micro-USB cables these days - they're often located in the cell phone area.

A bad USB cable can be the cause of a number of issues with the QuNexus. Check out the "Try a New Micro-USB Cable" section for some more info.

4.2 CV Trouble

If you are having trouble working with QuNexus' CV outputs and inputs this chapter should help. Make sure to read the main [CV](#) chapter above as well for even more information.

4.2.1 Steps to Convert MIDI to CV

There are many ways to use the QuNexus to convert MIDI to CV. A few different scenarios are listed. If you are having trouble, try following the set up instructions for the scenario that best fits your intended use.

CV OUTPUT:

Scenario 1: QuNexus plugged into a power supply (No Computer, No MIDI Expander)

Use Case: This is the simplest set up and works great if you just want the QuNexus Keyboard to play a CV Device.

1. Plug QuNexus into a power supply using a USB A to micro cable.
2. Plug the power supply into the wall or a power strip/extension cable.
3. Use a y cable that goes from STEREO 1/8in to dual MONO plugs or jacks. Usually the dual outputs are colored red and white (or black).
 - a. Use the red one for CV1 and the white (or black) one for Gate.
 - b. If plugged into the CV2 - 3 port use the red one for CV3 and the white (or black) one for CV2.

4. Plug the Stereo end of the y cable into the Gate - CV 1 port or the CV 2 - 3 port.
5. Plug the 2 MONO ends into the CV destinations on your CV device.
 - a. If plugged into the Gate - CV 1 port, the QuNexus presets send note ons and offs out the gate and pitch out CV1.
 - b. If plugged into the CV 2 - 3 port, the QuNexus presets B, C, and D send Pressure out CV 2 and Pitch Bend out CV 3. Preset A is very basic and doesn't use Pressure for anything or Tilt for Pitch Bend so these will not output if using QuNexus' Factory Preset A.
6. Play the QuNexus, it should work. (Make sure your CV device is connected to speakers/headphones).

Scenario 2: QuNexus powered through the MIDI Expander (No Computer)

Use Case: This is a good way to play your CV device with a different hardware MIDI device using QuNexus as a converter (the QuNexus can play the CV device as well).

1. Plug QuNexus into a MIDI Expander.
2. Plug the MIDI Expander into a wall.
3. Plug the MIDI Device's MIDI Output into the MIDI Expander's MIDI Input.
4. Use a y cable that goes from STEREO 1/8in to dual MONO plugs or jacks. Usually the dual outputs are colored red and white (or black).
 - a. Use the red one for CV1 and the white (or black) one for Gate.
 - b. If plugged into the CV2 - 3 port use the red one for CV3 and the white (or black) one for CV2.
5. Plug the Stereo end of the y cable into the Gate - CV 1 port or the CV 2 - 3 port.
6. Plug the 2 MONO ends into the CV destinations on your CV device.
 - a. If plugged into the Gate - CV 1 port, the QuNexus presets send note ons and offs out the gate and pitch out CV1.
 - b. If plugged into the CV 2 - 3 port, the QuNexus presets B, C, and D send Pressure out CV 2 and Pitch Bend out CV 3. Preset A is very basic and doesn't use Pressure for anything or Tilt for Pitch Bend so these will not output if using QuNexus' Factory Preset A.
7. Make sure your MIDI Device is outputting its MIDI on **Channel 2**. If you're using the QuNexus Factory Presets this is the Channel CV Layer is listening to. Note ons and offs will go out the Gate, note pitches will go out CV1, CC1 (Mod) will go out CV2, and pitch bends will go out CV3.
8. Play the QuNexus, it should work. (Make sure your CV device is connected to speakers/headphones).

Scenario 3: QuNexus plugged into the Computer (No MIDI Expander)

Use Case: In this scenario you can use the QuNexus Keyboard and/or MIDI Software on the computer to play a CV device. Ableton Live will be used as the software example in this scenario but you can check for all the same things using different software.

1. Plug QuNexus into a computer.
2. Open the Audio/MIDI software you wish to convert MIDI to CV with (like Ableton Live).
3. Check Ableton's MIDI Preferences to make sure QuNexus Port 1 and Port 3 are enabled for MIDI Input and Output.

4. Create a MIDI Track and set its "MIDI From" menu to QuNexus Port 1 (set channel to all channels or make sure you're using the same channel that the QuNexus preset is outputting it's MIDI Data on.
5. Set the "MIDI To" menu to QuNexus Port 3 (the CV port). Set the Channel to "Ch. 2" if you are using a Factory Presets. All Factory Presets use Channel 2 for CV output and input. If you are using a custom Preset check what channel you used in CV layer and make sure it is the same as the MIDI To channel in the MIDI Track in Ableton.
6. Use a y cable that goes from STEREO 1/8in to dual MONO plugs or jacks. Usually the dual outputs are colored red and white (or black).
 - a. Use the red one for CV1 and the white (or black) one for Gate.
 - b. If plugged into the CV2 - 3 port use the red one for CV3 and the white (or black) one for CV2.
7. Plug the Stereo end of the y cable into the Gate - CV 1 port or the CV 2 - 3 port.
8. Plug the 2 MONO ends into the CV destinations on your CV device.
 - a. If plugged into the Gate - CV 1 port, the QuNexus presets send note ons and offs out the gate and pitch out CV1.
 - b. If plugged into the CV 2 - 3 port, the QuNexus presets B, C, and D send Pressure out CV 2 and Pitch Bend out CV 3. Preset A is very basic and doesn't use Pressure for anything or Tilt for Pitch Bend so these will not output if using QuNexus' Factory Preset A.
9. Play the QuNexus, it should work. (Make sure your CV device is connected to speakers/headphones).

Scenario 4: QuNexus plugged into the Computer (With MIDI Expander)

Use Case: This is a good way to play CV with QuNexus, a different hardware MIDI device, and/or MIDI software on the Computer. This is the most complicated set up but it allows you to do everything the other three scenarios can do above. Ableton Live will be used as the software example in this scenario but you can check for all the same things using different software.

1. Plug QuNexus into the Computer like normal and then plug a MIDI Expander into QuNexus.
2. Plug the MIDI output from your MIDI Device into the MIDI Expander's MIDI In port.
3. Open the Audio/MIDI software you wish to convert MIDI to CV with (like Ableton Live).
4. Check Ableton's MIDI Preferences to make sure QuNexus Port 1, Port 2, and Port 3 are enabled for MIDI Input and Output.
5. Create a MIDI Track and set its "MIDI From" menu to "All Ins" (set channel to all channels).
6. Set the "MIDI To" menu to QuNexus Port 3 (the CV port). Set the Channel to "Ch. 2" if you are using a Factory Presets. All Factory Presets use Channel 2 for CV output and input. If you are using a custom Preset check what channel you used in CV layer and make sure it is the same as the MIDI To channel in the MIDI Track in Ableton.
7. Use a y cable that goes from STEREO 1/8in to dual MONO plugs or jacks. Usually the dual outputs are colored red and white (or black).
 - a. Use the red one for CV1 and the white (or black) one for Gate.
 - b. If plugged into the CV2 - 3 port use the red one for CV3 and the white (or black) one for CV2.

8. Plug the Stereo end of the y cable into the Gate - CV 1 port or the CV 2 - 3 port.
9. Plug the 2 MONO ends into the CV destinations on your CV device.
 - a. If plugged into the Gate - CV 1 port, the QuNexus presets send note ons and offs out the gate and pitch out CV1.
 - b. If plugged into the CV 2 - 3 port, the QuNexus presets B, C, and D send Pressure out CV 2 and Pitch Bend out CV 3. Preset A is very basic and doesn't use Pressure for anything or Tilt for Pitch Bend so these will not output if using QuNexus' Factory Preset A.
10. Make sure your MIDI Device is outputting its MIDI on **Channel 2**. If you're using the QuNexus Factory Presets this is the Channel CV Layer is listening to. Note ons and offs will go out the Gate, note pitches will go out CV1, CC1 (Mod) will go out CV2, and pitch bends will go out CV3.
11. Play the QuNexus, it should work. (Make sure your CV device is connected to speakers/headphones).

CV INPUT:

Scenario 1: QuNexus plugged into Computer (No MIDI Expander)

Use Case: In this scenario you can use an Expression Pedal (or any other uni-polar 0-5 Volt CV source) to control MIDI Software on the computer. Ableton Live will be used as the software example in this scenario but you can check for all the same things using different software.

1. Plug QuNexus into the Computer.
2. Open the Audio/MIDI software you wish to convert CV to MIDI with (like Ableton Live).
3. Check Ableton's MIDI Preferences to make sure QuNexus Port 1 and Port 3 are enabled for MIDI Input and Output. In Ableton, make sure to enable the remote column for Input from Port 1 and Port 3.
4. Plug a CV device into the Pedal / CV 1-2 In:
 - a. If using an Expression Pedal you can plug in with a stereo 1/8in connection.
 - b. For separate use of both CV 1 and 2 use a TRRS splitter like the one that comes in the [QuNexus CV Cable Kit](#) (click on the link for more information).
5. Go into MIDI Mapping Mode in Ableton Live and select the parameter you wish to control using CV.
6. Go into CoMA Mode using the QuNexus and follow the CoMA Mode instructions for mapping the [Expression pedal](#).
 - a. The Expression pedal will Map as CC# 112 on Channel 2 of QuNexus Port 3.
 - b. CV 2 will Map as CC# 113 on Channel 2 of QuNexus Port 3.
7. Exit MIDI Mapping Mode in Ableton Live.
8. Exit CoMA Mode on QuNexus.
9. Play the Expression Pedal (or other CV source), it should adjust the parameter.

Scenario 2: QuNexus powered through the MIDI Expander (No Computer)

Use Case: This is a good way to control a MIDI Device with an Expression Pedal (or any other uni-polar 0-5 Volt CV source).

1. Plug QuNexus into the MIDI Expander and plug the MIDI Expander into power.
2. Plug the MIDI Output from the MIDI Expander into the MIDI Input on your MIDI Device.

3. Plug a CV device into the Pedal / CV 1-2 In:
 - a. If using an Expression Pedal you can plug in with a stereo 1/8in connection.
 - b. For separate use of both CV 1 and 2 use a TRRS splitter like the one that comes in the [QuNexus CV Cable Kit](#) (click on the link for more information).
4. QuNexus' CV will enter the MIDI device as CC numbers on Channel 2.
 - a. The Expression pedal will use CC# 112
 - b. CV 2 will use CC# 113
5. Make sure the MIDI Device is set up to receive the correct CC# on Channel 2.
6. Play the Expression Pedal (or other CV source), it should talk to the MIDI Device.

Scenario 3: QuNexus plugged into Computer (With MIDI Expander)

Use Case: This is a good way to control a MIDI hardware device or MIDI software on a computer with an Expression Pedal (or any other uni-polar 0-5 Volt CV source). Ableton Live will be used as the software example in this scenario but you can check for all the same things using different software.

1. Plug QuNexus into the Computer.
2. Plug QuNexus into the MIDI Expander.
3. Plug the MIDI Output from the MIDI Expander into the MIDI Input on your MIDI Device.
4. Open the Audio/MIDI software you wish to convert CV to MIDI with (like Ableton Live).
5. Check Ableton's MIDI Preferences to make sure QuNexus Port 1 and Port 3 are enabled for MIDI Input and Output. In Ableton, make sure to enable the remote column for Input from Port 1 and Port 3.
6. Plug a CV device into the Pedal / CV 1-2 In:
 - a. If using an Expression Pedal you can plug in with a stereo 1/8in connection.
 - b. For separate use of both CV 1 and 2 use a TRRS splitter like the one that comes in the [QuNexus CV Cable Kit](#) (click on the link for more information).
7. Go into MIDI Mapping Mode in Ableton Live and select the parameter you wish to control using CV.
8. Go into CoMA Mode using the QuNexus and follow the CoMA Mode instructions for mapping the [Expression pedal](#).
 - a. The Expression pedal will Map as CC# 112 on Channel 2 of QuNexus Port 3.
 - b. CV 2 will Map as CC# 113 on Channel 2 of QuNexus Port 3.
9. Exit MIDI Mapping Mode in Ableton Live.
10. Exit CoMA Mode on QuNexus.
11. Make sure the MIDI Device is set up to receive the correct CC# on Channel 2.
12. Play the Expression Pedal (or other CV source), it should talk to the MIDI Device and adjust the parameter in the software.

4.2.2 Audible High Pitched Noise in Computer Audio When Using CV

Some may experience a high pitched frequency when using QuNexus with a laptop while connected to CV synths.

Causes:

It is possible that noise from the QuNexus LEDs can bleed into the power supply of the laptop, which might cause audible interference when mixing audio from the laptop with external synths. This can vary by computer and synth.

Solution:

Currently, there are three approaches to resolve this problem:

1. Power the QuNexus through the Expander Port instead of through the computer and use an external audio interface. If possible, power the audio interface from a wall wart.
2. Also try changing the LED Refresh mode options in the Hardware menu of the QuNexus Editor. Try Control Only first and see if that helps. Setting the LED Refresh Mode to Control Only means that the keyboard lights won't light up; only the side buttons will light up. LED feedback will behave normally in the Preset Select and Live Edit Modes. If the hum persists, try the "All Off" setting. The "All Off" setting disables any LED feedback on QuNexus.
3. Make sure to have a hot/loud signal coming out of the laptop so you don't have to put a lot of gain on it, and then if you need to you can reduce the signal later. The best use-case would be to run your audio into a mixer so you have more control over it. Using an external audio interface that has its own power will also help.

4.2.3 QuNexus LEDs Light Up Erratically When Receiving CV Input

You've set up your QuNexus to receive CV from a synth through the CV Input port. You're all ready to go so you try it out and suddenly the LEDs of the QuNexus begin to flash strangely and you're not sure why.

Causes:

QuNexus' CV Input is uni-polar and is meant for a signal up to 5 Volts. If you send it a bi-polar signal or a signal above 5 Volts, the signal will be clipped and can cause malfunctions in extreme cases. One way these malfunctions can manifest would appear to be erratic LED behavior. Don't worry, nothing is damaging your QuNexus. What is happening is the QuNexus is going in and out of Preset Select Mode and Live Edit Mode. The details of why QuNexus malfunctions this particular way aren't important -- just know that your QuNexus is not being harmed, it just isn't meant to receive bi-polar CV or signals above 5 Volts.

Solution:

Make sure the CV signal you are sending QuNexus is uni-polar and within a 0-5 Volt range.

You can convert a bi-polar 10V signal to a uni-polar 5V signal. Though we do not provide a converter, you can make one using the schematic shown below:

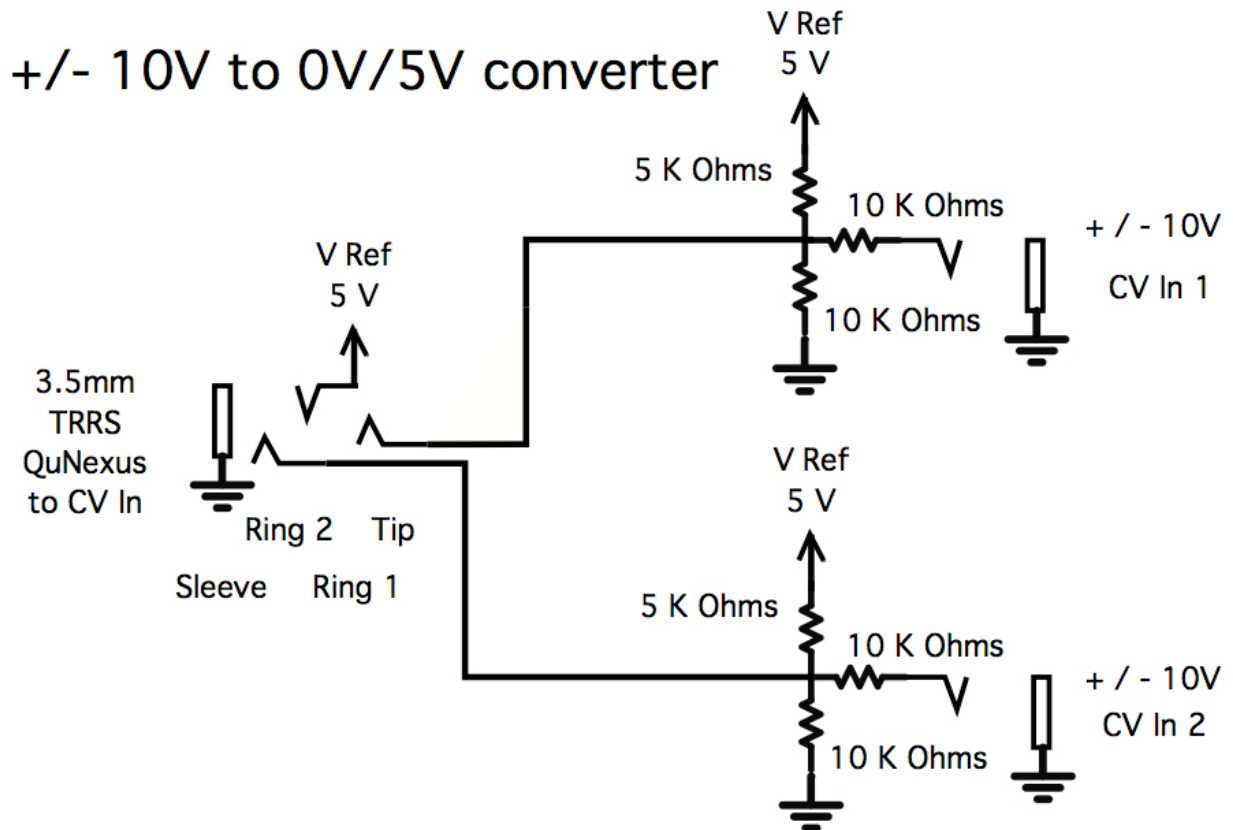

4.3 Firmware Trouble

If you are having trouble with your QuNexus Firmware, are experiencing odd behavior after an update, or just want to know more about firmware, then this is the chapter for you.

4.3.1 QuNexus Doesn't Do Anything After a Firmware Update

Sometimes after updating the firmware on your QuNexus it will appear to not be doing anything, even if it was working without issue just before updating. Not everything will light up properly and not everything will be outputting correct MIDI.

Causes:

This is typically caused by updating the firmware on your QuNexus and then not updating the presets. A firmware update also restores the factory presets to their original states. If you've created your own custom presets using the QuNexus Editor you will need to resend them to your QuNexus.

Solution:

Update your presets!

To do this, simply send each preset to the desired QuNexus preset slot (A, B, C, or D) in the QuNexus Editor while your QuNexus is connected (make sure it says "Connected" just above the QuNexus logo). Once the update is done your QuNexus should be back to normal.

4.3.2 Firmware Update Freezes or Doesn't Work

It is possible that when trying to update the firmware on your QuNexus the update process freezes and does not complete. This problem is pretty much exclusive to Windows machines, most often Windows 8.

Typical behavior is that the firmware update will begin, the shift button will light up blue on the QuNexus, but nothing else ever happens - it just kind of hangs there. It will seem like the only thing that can be done is to cancel the firmware update and try again.

Causes:

Why this problem happens is more of a mystery than the other potential problems. Windows 8 users experience this the most, so there is likely something that the editor does that it doesn't like very much. You may also want to check and make sure that you don't [have a bad USB cable](#) - it may just be that the bad cable is disconnecting your QuNexus during the firmware update. You also might want to try plugging in your QuNexus after opening the editor, not before.

Solution:

If firmware updates are freezing on your machine it may help to try this:

- Open the QuNexus Editor and connect the QuNexus
- Begin the firmware update - either by the automatic prompt that pops up, or by going to the Hardware menu and selecting "Update Firmware"
- When the update begins and the progress bar appears, **disconnect the QuNexus** for a second or two and then **reconnect** it
- You should get a message that your firmware is out of date and needs an update - do so
- This time the update should go through without issue

- Once done, remember to update your presets

Don't worry about unplugging your QuNexus while the firmware update is in progress - you're not going to hurt it and it will not be damaged.

4.3.3 General Firmware Information and Suggestions

This section contains potentially helpful information and suggestions regarding QuNexus, its firmware, and things to look for when troubleshooting.

4.3.3.1 Unplug Other USB Devices

While having other USB devices plugged in at the same time as your QuNexus should not be an issue, there may be some rare cases where other devices may interfere with your ability to properly update the firmware on your board.

If you're having troubles updating your firmware or connecting to the editor, you may want to try unplugging any other USB devices leaving just the QuNexus plugged in, then open up the QuNexus Editor and see if that helps. Once the firmware has updated you can plug everything back in.

If you have multiple devices plugged in, you might want to experiment and see if there is one particular device that is causing the problem. Then you'll know exactly which one to unplug if you need to update your firmware again.

4.3.3.2 Try a New Micro-USB Cable

Many problems with updating firmware, and just general operation, can be caused by the often overlooked bad USB cable. It is always a good idea to have at least one backup cable (not just with QuNexus, but with anything) for troubleshooting purposes and other "emergencies".

Things to look for that can potentially be solved by a new cable:

- QuNexus turning on/off at the slightest touch
- QuNexus getting stuck in bootloader mode (blue shift button stuck on and not responding to anything)
- Firmware update not completing properly, or freezing
- QuNexus not connecting to QuNexus Editor

4.3.3.3 “Hotplugging” on Windows

On Windows machines it is possible to experience some connectivity issues between QuNexus and the QuNexus Editor. This is true for Macs as well, but this issue is much more prevalent on computers running Windows operating systems.

If your QuNexus is plugged in but the QuNexus Editor is still showing “not connected” above the QuNexus logo (meaning it can’t find the QuNexus) after you open it, you should try reversing the steps. First, open the editor, then plug in the QuNexus once the editor is open. In some cases you just need to find the proper order of operations to get things working right.

If this doesn’t resolve the issue you may want to [try a new USB cable](#), make sure you don’t have any other Audio/MIDI applications open at the same time as the QuNexus Editor (Windows won’t allow multiple applications to be connected to a class-compliant MIDI device simultaneously), or try [unplugging other USB devices](#).

4.3.3.4 Don’t Send MIDI to QuNexus During an Update

When performing a firmware update, it is *highly* recommended that you do not send MIDI messages to the QuNexus from another application (e.g. sending remote LED messages from Ableton Live to the QuNexus). If you do this, the update will likely fail.

Firmware on the QuNexus is transmitted via System Exclusive messages (SysEx), which are essentially just special MIDI messages. If you send other MIDI messages while the SysEx message is being transmitted things can get confused and go awry. You won’t hurt your QuNexus if you do this, but you will have to stop sending MIDI to it and then restart the firmware update for it to complete successfully. It’s also potentially possible to get stuck in bootloader mode when doing this.

Note: this problem is much more likely to occur on Mac OS than it is on Windows, as currently Windows does not allow more than one application to be connected to a class-compliant MIDI device (which the QuNexus is) simultaneously. Mac OS does not have this limitation, so you can be sending MIDI to the QuNexus from a number of sources while the editor is open and updating the firmware.

4.3.3.5 If Things are Working Fine, DON’T Update Right Before your Show

When there’s a new update available it can be very tempting to get it and update as soon as you possibly can. While there’s nothing wrong with this urge, if you happen to have a show coming up anytime soon (or today), it is generally advisable to hold off on updating until after your show has passed - or at least keep your old versions so you can go back if need be.

While we test everything to the best of our ability, there’s no telling what bugs may be introduced to your setup - the preset you’re using may have changed in a subtle way that you don’t notice, there could be a nasty bug that just didn’t get noticed, the new firmware may not like one of your

other devices, or it may respond to MIDI in a slightly different, perhaps undesirable way. Even fixing a bug with an update can cause problems if you've already grown accustomed to the "buggy" behavior and developed the muscle memory around it.

Always give yourself time to test things out before changing your performance setup. Always. You will be much less stressed if you know what to expect from your gear and software. This is an extremely useful suggestion for pretty much anything performance related, not just QuNexus.

4.3.3.6 Manually Updating Firmware

Typically the QuNexus Editor will do just fine updating firmware on your board, but in some cases it may be necessary to manually update your firmware. To update your firmware...

MAC:

1. If you have not already, downloaded and install SysEx Librarian from <http://snoize.com/SysExLibrarian/>
2. Download or locate the firmware file you would like to install, along with the "Enter Bootloader" sysex command file (zip files for your current version and past versions can be downloaded here: http://files.keithmcmillen.com/downloads/qunexus/sysex_files/)
3. Plug in your QuNexus and open SysEx Librarian
4. Click "Add..." in the lower-left corner of the screen. When the browser window opens, navigate to the firmware file (generally named to the effect of "QuNexus_Firmware_1.0.0.syx") and hit "Open"
5. Repeat the previous step but navigate to the Enter Bootloader sysex file, typically named "QuNexus_enter_bootloader.syx"
6. Select QUNEXUS Port 1 (or Port 1) from the drop down menu labeled "Destination"
7. Now select the QuNexus_enter_bootloader.syx file in the main window of the SysEx Librarian application. Once selected it should become highlighted blue.
8. Click the "Play" button in the top-left corner. A progress bar will very quickly appear and disappear, and the blue shift button on your QuNexus should light up solid. Your QuNexus is now in bootloader mode and ready to receive firmware.
9. The destination menu will have reset when your QuNexus went into bootloader mode, so reselect QuNexus Port 1 from the drop down menu.
10. Select the firmware file you want to send to your QuNexus in the main windows to SysEx Librarian.
11. Click the "Play" button to start sending the firmware. A progress bar will appear indicating how far along the update process is and the shift button on your QuNexus will begin flashing as the update progresses.
12. Once done, the LEDs on your QuNexus should swipe across the board as though it is powering on. Your firmware has been updated!

WINDOWS:

1. If you have not already, download and install SysEx Box from <http://miostools.midimox.org> (it's at the top of the page)

2. Download or locate the firmware file you would like to install, along with the “Enter Bootloader” sysex command file (zip files for your current version can be downloaded here: http://files.keithmcmillen.com/downloads/qunexus/sysex_files/)
3. Plug in your QuNexus and open SysEx Box
4. Select QUNEXUS Port 1 (or Port 1) in the MIDI In and MIDI Out ports
5. Click “Open Sysex File”. When the browser window opens, navigate to the enter bootloader file (typically named “enter_bootloader.syx”) and click “Open”
6. Click the “Send Sysex” button - the blue shift button on your QuNexus should light up solid. Your QuNexus is now in bootloader mode and ready to receive firmware
7. Make sure the MIDI In and MIDI Out ports still say QuNexus
8. Click “Open Sysex File” again. This time select the firmware file you want to send to your QuNexus, then click “Open”
9. Click the “Send Sysex” button - the blue shift button on your QuNexus should start flashing. The firmware update will take a moment.
10. Once the update is complete the LEDs on your QuNexus should swipe across the board as though it is powering on. Your firmware has been updated!

Safety Precautions



Medical Devices

QuNexus may emit electromagnetic fields. These electromagnetic fields may interfere with pacemakers or other medical devices. If you wear a pacemaker, maintain at least 6 inches (approximately 15 cm) of separation between your pacemaker and QuNexus. If you suspect QuNexus is interfering with your pacemaker or any other medical device, stop using QuNexus and consult your physician for information specific to your medical device.

Medical Conditions

If you have any medical condition that you believe could be affected by QuNexus (for example, seizures, blackouts, eyestrain, or headaches), consult with your physician prior to using QuNexus.

Explosive Atmospheres

Do not use QuNexus in any area with a potentially explosive atmosphere, such as at a fueling area, or in areas where the air contains chemicals or particles (such as grain, dust, or metal powders). Obey all signs and instructions.

Repetitive Motion

When you perform repetitive activities such as playing the keyboard on QuNexus, you may experience occasional discomfort in your hands, arms, wrists, shoulders, neck, or other parts of your body. If you experience discomfort, stop using QuNexus and consult a physician.

High-Consequence Activities

QuNexus is not intended for use where the failure of the device could lead to death, personal injury, or severe environmental damage.

Choking Hazard

Some QuNexus accessories may present a choking hazard to small children. Keep these accessories away from small children.